O.S. ENGINE O.S. FS-26S-C & FS-26S-CX

OWNER'S INSTRUCTION MANUAL

It is of vital importance, before attempting to operate your engine, to read the general **'SAFETY INSTRUCTIONS AND WARNINGS'** section on pages 2-5 of this booklet and to strictly adhere to the advice contained therein.

- Also, please study the entire contents of this instruction manual, so as to familiarize yourself with the controls and other features of the engine.
- Keep these instructions in a safe place so that you may readily refer to them whenever necessary.
- It is suggested that any instructions supplied with the vehicle, radio control equipment, etc., are accessible for checking at the same time.



CONTENTS

SAFETY INSTRUCTIONS AND WARNINGS ABOUT YOUR O.S. ENGINE-----	2~5	VALVE ADJUSTING -----	17~19
BASIC ENGINE PARTS-----	6	CARE & MAINTENANCE -----	19~20
ENGINE INSTALLATION-----	7	PARTS REPLACEMENT-----	20
AIR CLEANER TYPE 101 -----	8	GENUINE PARTS & ACCESSORIES -----	21
NOTES CONCERNING THE RECOIL STARTER ----	9	FS-26S-C EXPLODED VIEW & PARTS LIST -----	22~23
GLOWPLUG-----	10	FS-26S-CX EXPLODED VIEW & PARTS LIST -----	24~25
TOOLS, ACCESSORIES, etc.-----	11~12	CARBURETTOR EXPLODED VIEW & PARTS LIST-----	26
PRESSURIZED FUEL SYSTEM-----	12	THREE VIEW DRAWING-----	27~28
STARTING, RUNNING AND ADJUSTMENT-----	13~16		
IF THE ENGINE FAILS TO START -----	16		

SAFETY INSTRUCTIONS AND WARNINGS ABOUT YOUR O.S. ENGINE

Remember that your engine is not a "toy", but a highly efficient internal-combustion machine whose power is capable of harming you, or others, if it is misused.

As owner, you, alone, are responsible for the safe operation of your engine, so act with discretion and care at all times.

If at some future date, your O.S. engine is acquired by another person, we would respectfully request that these instructions are also passed on to its new owner.

- The advice which follows applies basically to **ALL MODEL ENGINES** and is grouped under two headings according to the degree of damage or danger which might arise through misuse or neglect.



WARNINGS

These cover events which might involve serious (in extreme circumstances, even fatal) injury.



NOTES

These cover the many other possibilities, generally less obvious sources of danger, but which, under certain circumstances, may also cause damage or injury.



WARNINGS

- Model engine fuel is poisonous. Do not allow it to come into contact with the eyes or mouth. Always store it in a clearly marked container and out of the reach of children.



- Model engine fuel is also highly flammable. Keep it away from open flame, excessive heat, sources of sparks, or anything else which might ignite it. Do not smoke or allow anyone else to smoke, near to it.



- Never operate your engine in an enclosed space. Model engines, like automobile engines, exhaust deadly carbon-monoxide. Run your engine only in an open area.

- Model engines generate considerable heat. Do not touch any part of your engine until it has cooled. Contact with the muffler (silencer), cylinder head or exhaust header pipe, in particular, may result in a serious burn.





NOTES

- This engine is intended for model cars. Do not attempt to use it for any other purpose.
- Mount the engine in your model securely, following the manufacturers' recommendations, using appropriate screws and locknuts.
- Fit an effective silencer (muffler). Frequent close exposure to a noisy exhaust (especially in the case of the more powerful high-speed engines) may eventually impair your hearing and such noise is also likely to cause annoyance to others over a wide area.
- The wearing of safety glasses is also strongly recommended.
- Take care that the glowplug clip or battery leads do not come into contact with rotating parts. Also check that the linkage to the throttle arm is secure.
- For their safety, keep all onlookers (especially small children) well back (at least 20 feet or 6 meters) when preparing your model for running.



NOTES

- To stop the engine, fully retard the throttle stick and trim lever on the transmitter, or, in an emergency, cut off the fuel supply by pinching the fuel delivery tube from the tank.
- Do not attempt to disassemble the recoil starter of the 12CV-X. If you do so, the very strong spring inside will be suddenly ejected. This can be very dangerous.
- Do not extend the starter cord more than 45cm (18"). Do not abruptly release the operating handle. Allow the cord to rewind smoothly while still holding the handle.
- Pull the operating handle straight out when starting the engine, so that the cord does not rub against the vehicle body or engine. This will help prevent the cord from being damaged by abrasion or engine heat.
- Warning! Immediately after a glowplug-ignition engine has been run and is still warm, conditions sometimes exist whereby it is just possible for the engine to abruptly restart if it is rotated over compression WITHOUT the glowplug battery being reconnected.

INTRODUCTION

These are overhead-valve four-stroke-cycle engines designed for 1/10 scale radio-controlled model cars. They are based on the latest version of the well-established FS-26S aircraft engine, incorporating many improved or purpose designed parts, including a special crankshaft, revised camshaft, stronger valve-springs and new carburettor with short straight through inlet tract to the combustion-chamber for improved breathing. The engine is distinguished by a black-anodized crankcase and rocker-cover and is supplied complete with an O.S. Super Air Cleaner as standard.

The FS-26S-CX is equipped with a built in recoil starter system which eliminates the need for a separate electric starter and starter battery.

BASIC ENGINE PARTS

FS-26S-CX

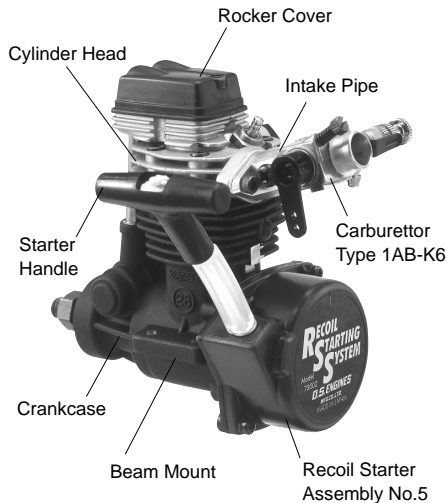

INSTALLING THE GLOWPLUG

Install the washer on the glowplug and insert carefully into cylinder-head, making sure that it is not cross-threaded before tightening firmly.

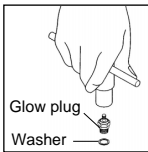

ENGINE INSTALLATION

Make sure that the vehicle's engine mounting surfaces are level and in the same plane. Poor installation may cause distortion of the crankcase, bearings, etc., resulting in erratic running and loss of performance. The recommended screws for securing the engine are 3mm or 4-40 steel Allen hexagon socket type. If existing holes in the engine mount do not align perfectly with engine

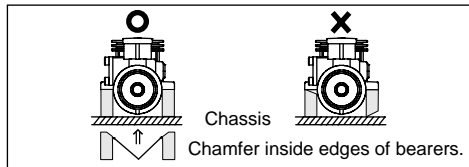

mounting lugs, enlarge them slightly with a needle-file so that screws enter vertically. Avoid forcing the screws. Secure with locknuts. If the bottom of the recoil starter housing would otherwise touch the car chassis, install the engine mount spacers (supplied) between the engine's mounting lugs and the engine mount. Use the M3x15 screws provided. With some vehicles, it may be necessary to make minor trimming modifications to chassis or body when fitting the engine.

NOTE:

Where spacers are supplied joined in pairs (see sketch), separate them as shown. Either face may be placed downwards.

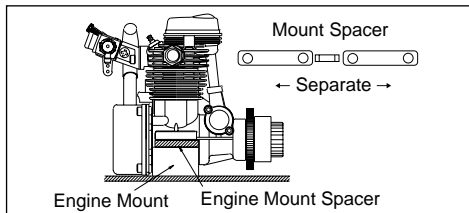

AIR CLEANER TYPE 101

This is a heavy-duty wet type air cleaner that has been developed specifically for O.S. model car engines. It contains specially impregnated filter elements which prevent highly damaging dust and dirt from being drawn into the engine through the carburettor, yet allow engine performance to be maintained for longer periods between element renewals. The Type 101 air cleaner has a special rubber body which facilitates easy yet secure fitting, with positive sealing at the carburettor air intake.

INSTALLATION OF AIR CLEANER

- Carefully clean the carburettor, removing any old adhesive or sealant that may have been previously used on the outside of the air intake.
- Press the air cleaner body firmly over the carburettor air intake. Make sure that the outer rim of the intake engages the internal annular groove in the air cleaner: failure to do so may result in the air cleaner falling off. See sketch, right.

FILTER ELEMENTS

- The elements are already impregnated with a special filter oil. As this oil is very sticky, take care, when handling it, to prevent dust or dirt from adhering to the elements. If your fingers become contaminated, wash them with soap and water.
- During storage, the oil may have become unevenly dispersed through the elements. This will be indicated if the blue color of the element material appears patchy. In this case, place the elements in a small plastic bag and gently rub them between finger and thumb to redistribute the oil.

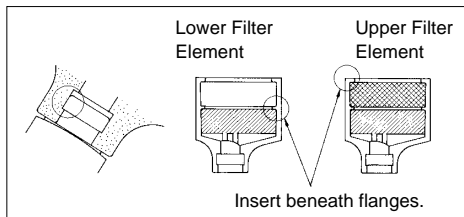

REPLACEMENT OF ELEMENTS

It is advisable to replace the upper filter element with a new one after not more than one hour of running time. It is not necessary to discard the lower element as frequently, but be sure to change it when it becomes soiled. Always remove contaminated elements carefully, to ensure that dirt cannot enter the carburettor.

NOTES CONCERNING THE RECOIL STARTER

(FS-26S-CX ONLY)

REMINDER!

- ◆ Do not attempt to disassemble the recoil starter. If you do so, the very strong spring inside will be suddenly ejected. This can be very dangerous.
- ◆ Do not extend the starter cord more than 45cm(18"). Do not abruptly release the operating handle. Allow the cord to rewind smoothly while still holding the handle.
- ◆ Pull the operating handle straight out when starting the engine, so that the cord does not rub against the vehicle body or engine.

- ◆ This will help prevent the cord from being damaged by abrasion or engine heat.
- ◆ Try to avoid spilling fuel over the starter unit and its cord. Some fuels have a detrimental effect on these parts.
- ◆ The starter prevents the engine from being rotated in the wrong direction. The unit will be damaged if you attempt to force the flywheel in the opposite direction (i.e. clockwise when viewed from the crankshaft end).

NOTE:

Because, in the interests of personal safety, dismantling of the starter mechanism is strongly discouraged, the Recoil Starter is available for replacement only as a pre-assembled unit. However, some related parts, such as Starting Shaft and Rear Adaptor, are obtainable separately. (See Parts List.)

GLOWPLUG

The FS-26S-C and FS-26S-CX are supplied with an O.S. Type F glowplug, specially designed for O.S. four-stroke engines.

The role of the glowplug

With a glowplug engine, ignition is initiated by the application of a 1.5-volt power source. When the battery is disconnected, the heat retained within the combustion chamber remains sufficient to keep the plug filament glowing, thereby continuing to keep the engine running. Ignition timing is 'automatic' : under reduced load, allowing higher rpm, the plug becomes hotter and, appropriately, fires the fuel/air charge earlier; conversely, at reduced rpm, the plug become cooler and ignition is retarded.

Glowplug life

Particularly in the case of very high performance engines, glowplugs must be regarded as expendable items.

However, plug life can be extended and engine performance maintained by careful use, i.e.:

- Install a plug suitable for the engine.
- Use fuel containing a moderate percentage of nitromethane unless more is essential for racing events.
- Do not run the engine too lean and do not leave the battery connected while adjusting the needle.

When to replace the glowplug

Apart from when actually burned out, a plug may need to be replaced because it no longer delivers its best performance, such as when:

- Filament surface has roughened and turned white.
- Filament coil has become distorted.
- Foreign matter has adhered to filament or plug body has corroded.
- Engine tends to cut out when idling.
- Starting qualities deteriorate.

TOOLS, ACCESSORIES, etc.

The following items are necessary for operating the engine.

FUEL

Use only top quality methanol-based model engine fuel. For consistent performance and long engine life, it is advisable to use fuel containing AT LEAST 18% lubricant. This engine is designed to run on both low and high nitromethane content fuels, i.e. from mild mixtures containing small percentage of nitromethane, up to high-speed racing fuels containing 40% nitromethane. Generally, power output is increased—up to a certain point—as the nitromethane content of the fuel is increased. As a starting point, we recommend a fuel containing 10-20% nitromethane, changing to a fuel containing more nitro only if necessary. When the nitro content of the fuel is increased or the brand of fuel is changed, it is advisable to initially run the engine with a richer needle-valve setting, so that the optimum setting for the new fuel may be rechecked

rechecked as described in the RUNNING-IN paragraphs. When engines are run at very high speeds and on high-nitro fuels, glowplug elements will not last as long.

Reminder!



Model engine fuel is poisonous. Do not allow it to come into contact with the eyes or mouth. Always store it in a clearly marked container and out of the reach of children.



Model engine fuel is also highly flammable. Keep it away from open flame, excessive heat, sources of sparks, or anything else which might ignite it.

BATTERY INTEGRATED GLOWPLUG HEATER

Commercially available handy glowplug heater in which the glowplug battery and battery leads are integrated.

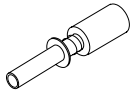

ELECTRIC STARTER AND STARTER BATTERY

Use a 12-volt electric starter with suitable battery for starting the engine.(FS-26S-C)

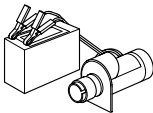

LONG SOCKET WRENCH

Recommended for easy removal and replacement of the angled and recessed glowplug, the O.S.Long Socket Wrench incorporates a special grip.

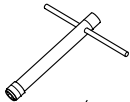

FUEL PUMP

For filling the fuel tank, a simple, polyethylene "squeeze" bottle, with a suitable spout, is required.



SILICONE FUEL LINE

Heatproof silicone tubing of approx. 5mm o.d. and 2mm i.d. is required for the connection between the fuel tank and engine.

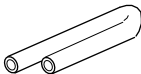

PRESSURIZED FUEL SYSTEM

- The somewhat violent changes of vehicle attitude that occur in off-road running, combined with the fact that, in buggy type cars, the fuel tank is often located some distance from the carburettor, means that fuel 'head' at the carburettor can vary and upset running. Therefore, it is recommended that a muffler pressurized fuel feed system be used.
- Never run your vehicle without the air cleaner. Dust and dirt that may otherwise be drawn into the engine will rapidly shorten its life.

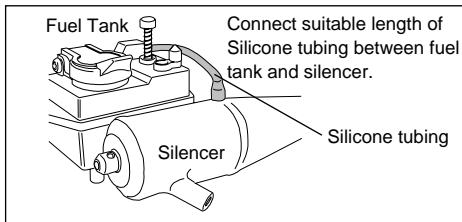

STARTING, RUNNING AND ADJUSTMENT

In the interests of a long working life and high performance, every internal-combustion engine needs to be "run-in" (or "broken-in" as the procedure is also known). This means giving the engine extra care and attention during the first hour or so of its operational life. New parts need to become "bedded-in", i.e. smoothed and aligned to reduce friction and avoid distortion. For this to take place, the engine must not be overloaded or run too fast. The essential ingredients here, are ample lubrication and cooling. Such a condition is achieved by having the engine operate on an extremely rich needle-valve setting : the excess oil not only provides an abundance of lubrication; it also conducts away heat from the surrounding metal and this is further assisted by the partial evaporation of the alcohol content of the fuel.

With an aircraft engine, cooling is also aided, in large measure, by the slipstream and some model car enthusiasts elect to carry out initial running-in, in this way by bench-mounting the engine and temporarily fitting it with an aircraft type drive hub and propeller. In the case of the O.S. FS-26S-C, however, the fact that it is a four-stroke engine with inlet pipe and carburettor mounted high on the cylinder-head, means that each charge of rich, cooling, fuel-air mixture is admitted directly into the cylinder, instead of being pre-heated in a lengthy journey via the crankcase, as in the usual two-stroke model car unit. With extra care, the FS-26S-C can, therefore, be run-in ready-installed in the car.

- Turn the needle-valve gently clockwise until it stops. Do not use force to turn the needle beyond this point. Now reopen it 2 turns.

- Set the throttle-stop screw so that the minimum throttle opening (idle setting) is approximately 1.5mm.

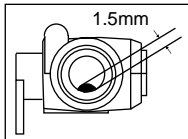

- Switch on the transmitter, followed by the receiver. Close the throttle stick and open the throttle trim lever to the idle setting.
- Connect the glowplug battery and apply the electric starter. As soon as the engine starts, disconnect the glowplug battery, keeping the engine running slowly on the rich needle setting. (If necessary, make a slight readjustment to the throttle stick to keep the engine idling steadily.) If the engine stops, allow it to cool for a minute or two before restarting it. In fact, short runs, interrupted by brief cooling-off periods is good practice during running-in.

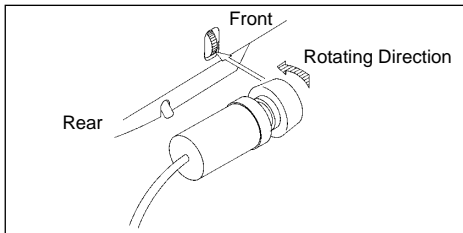

- When the FS-26S-CX is installed in certain ready-to-run cars:

- Press choke button on car's fuel tank sufficient to prime carburetor. (Do not overprime!)

- Making sure that glowplug remains switched off, check that starter handle can be pulled out, then re-connect plug and operate starter briskly until engine starts.

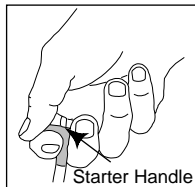

Note!

Four stroke engine have stronger compression than two stroke engines.

Hold the chassis firmly when pulling the recoil starter. Also, wearing of gloves is recommended to avoid any risk of injury.

Remember!

It is vitally important to set the throttle at the correct position before attempting to start the engine. If the engine is allowed to run with the throttle too far open under "no load" conditions, it will rapidly overheat and may be seriously damaged.

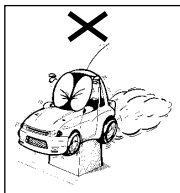

- Now, refuel and re-start the engine, opening the throttle just sufficiently to engage the centrifugal clutch and allow the car to run on the track without stalling and still with the needle-valve set rich to promote cool running.

- After running the engine for four or five tanks of fuel, begin closing the needle a few degrees (1 to 3 clicks) between succeeding runs. Also, vary its speed, from idling to medium RPM, with the throttle. See sketch.
- Eventually, the engine will begin to loosen up sufficiently to allow short bursts of full-throttle acceleration with the needle-valve at its optimum setting.

Note!

Do not close the needle-valve any further. If you do so, the engine will begin to overheat and the car will slow down, accompanied by visibly diminished exhaust smoke. In this event, bring the vehicle to a halt immediately and reopen the needle-valve 20° to 30°.

- Now open the needle-valve 20°-30° from the setting at which the highest straight line speed is obtained. This slightly rich setting should provide the optimum balance. Run the car for about three more tanks of fuel to allow fine-tuning of any final adjustments.

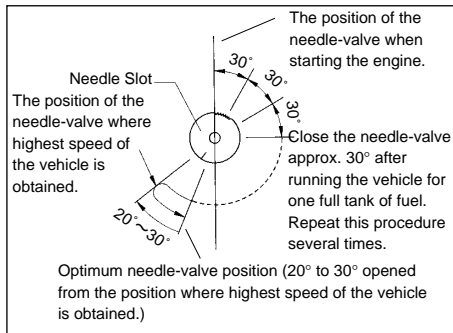

- To stop the engine, close the throttle to idling speed, then shut it off completely with the trim lever on the transmitter. To cut off the fuel supply, pinch the fuel delivery tube to the carburettor.

IF THE ENGINE FAILS TO START

- **Check the following:**
- Glowplug battery discharged or glowplug defunct.
- Fuel not reaching carburettor.
- Engine flooded. Do not over-prime. (This could also cause hydraulic lock and damage the engine on application of the electric starter.) Remove glowplug, close needle-valve and apply starter to pump out surplus fuel. (Cover the plug hole with a foiled cloth, so that fuel cannot splash into your face.)

For 26S-CX

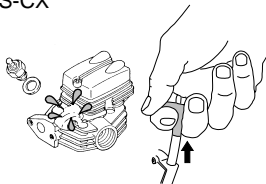

VALVE ADJUSTING

ALL O.S. four-stroke engines have their valve(tappet) clearances correctly set before they leave the factory. However, if, after many hours of running time have been logged, a loss of power is detected, or if the engine has to be disassembled or repaired as a result of an accident, valve clearances should be checked and readjusted, as necessary. O.S. Valve Adjusting Tool Kit is available as optional accessory.

The kit comes in a plastic case and includes:
(Code No.72200060)

- Feeler gauge 0.04mm
- Wrench 5mm
- Feeler gauge 0.1mm
- Screwdriver
- Hex. key 1.5mm

Note:

Valve clearances of all O.S. four-stroke-cycle engines must be checked and reset ONLY WHEN THE ENGINE IS COLD. Procedure is as follows.

(I)

- 1.Remove the cover from the rocker-box on top of the cylinder-head, using the correct size Allen hex key.
- 2.Turn the flywheel counter-clockwise until compression is first felt, then turn it a further quarter revolution. At this point, both valves should be closed. (If the prop driver ('drive hub') of your engine is engraved with a letter 'T', this mark should now be at the top.)
- 3.The standard valve clearance, on both inlet and exhaust valves, is between 0.04mm and 0.10mm(0.0015-0.004 inch), measured between valve stem and rocker arm. Use the 0.04mm and 0.10mm feeler gauges to check clearances.

(See Fig.1.)

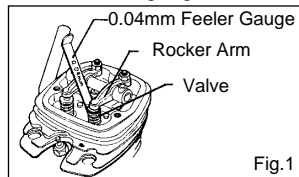

Fig.1

Note:

If the gap is found to be less than 0.04mm, it is not necessary to readjust the clearance if the engine has good compression and starts easily. Equally, if the gap exceeds 0.10mm but is not more than 0.14mm (i.e. the thickness of both feeler gauges inserted together), it is not essential to readjust the clearance if the engine runs satisfactorily.

(II)

If a clearance is found to be outside either of these limits, it should be reset as follows.

1. Carefully loosen locknut on rocker-arm 1/4-1/2 turn with a 5mm wrench. (Fig.2.)

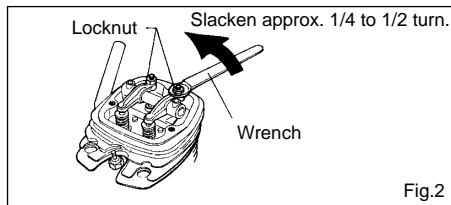

2. Turn adjusting-screw approx. 1/2 turn counter-clockwise to open gap, using appropriate tool - i.e. Allen hex key. (Fig.3.)

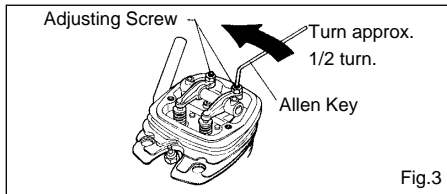

3. Insert 0.04mm feeler gauge between valve stem and rocker-arm and gently turn adjusting screw clockwise until it stops.(Fig.4.)

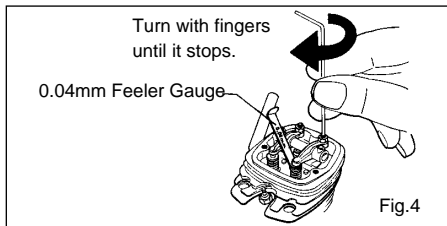

4. Re-tighten locknut while holding adjusting screw stationary. (Fig.5.)

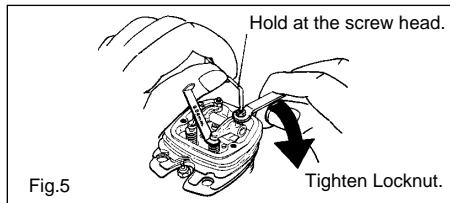

5. Remove 0.04mm feeler, rotate the crankshaft through two revolutions and recheck gap.
6. If clearance is correct, slacken locknut on the other rocker-arm and repeat steps 1 to 5 above. Finally, replace rocker box cover.

Remember:

Excessive valve clearance will cause loss of power, due to valve (s) not opening sufficiently. On the other hand, a total loss of clearance may cause difficult starting due to valves not closing properly, resulting in loss of compression.

CARE & MAINTENANCE

- At the end of each operating session, drain the fuel tank, then energize the glowplug and try to re-start the engine to burn off any fuel that may remain inside. Repeat this procedure until the engine fails to fire. Then remove the glowplug and drain off any residue while the engine is still warm.
- Inject some corrosion-inhibiting after-run oil and rotate the crankshaft to distribute oil to the working parts. Do not inject such oil into the carburettor, however, as it may cause deterioration of the carburettor's O-ring seals.
- Apply a little lubricating oil to the rocker shaft and rocker arms.

Note!

These maintenance procedures will reduce the risks of corrosion or starting difficulties after a period of storage.

- When cleaning the exterior of the engine, use methanol or kerosene. Do not use gasoline or any solvent that might damage the silicone fuel tubing.

PARTS REPLACEMENT

- Over a long period, depending on how well your engine has been protected from the ingress of dust and grit and other causes of wear and tear, loss of performance may eventually occur in the form of reduced power, reluctant starting, unstable idling, etc. Having checked that this is not due merely to the need to readjust the valve clearances (for which an O.S. Valve Adjustment Kit - Code No. 72200060 - is available) inspection may then reveal that the replacement of some parts may be called for.
Contact the O.S. distributor in your country for parts or full service. See pages 21 of this booklet for details of parts.

GENUINE PARTS & ACCESSORIES

O.S. SPEED

RACING ENGINE PARTS

■ O.S.Glow Plug

TYPE F
(71615009)



■ Super Joint Tube 15

(72103310)



■ T-1020 Tuned Silencer

(72103020)



■ F-2000 4C Car Silencer

(44125100)



■ Super Air Cleaner 101

(72403100)

■ Dust Cap Set

φ4 (73300305)

For Carburettor Nipple

■ 101,102 Filter Elements

(72403120)

(6pcs.)

φ7 (73300712)

For T-1020 Tuned Silencer

■ Hyper Exhaust

(44126000) For KYOSHO Super Ten

(44126010) For KYOSHO Pure Ten



■ Valve Adjusting Tool Kit

(72200060)



■ Long Socket Wrench With

Plug Grip (71521000)

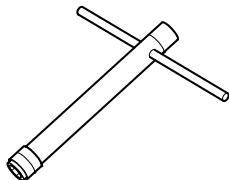

FS-26S-C EXPLODED VIEW

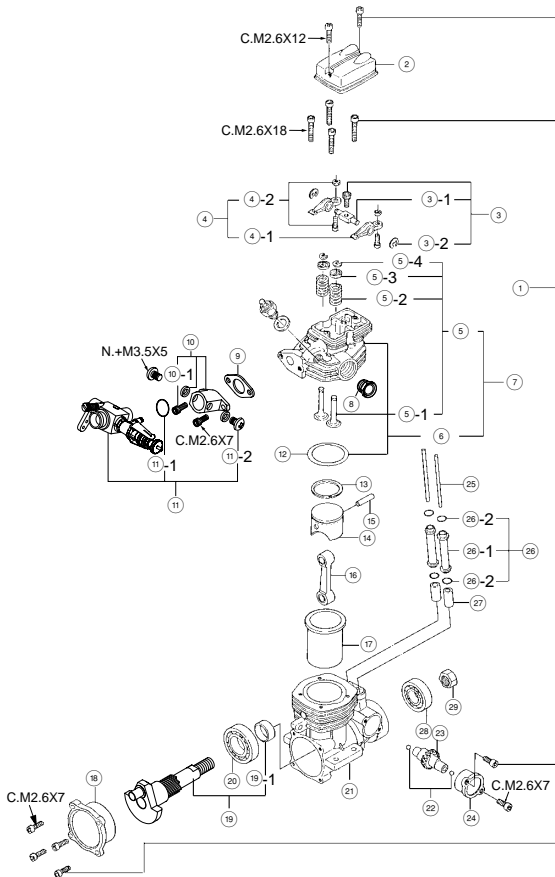

* Type of screw

C···Cap Screw B···Binding Head Screw M···Oval Fillister-Head Screw

F···Flat Head Screw N···Round Head Screw S···Set Screw

No.	Code No.	Description
①	4 4113 000	Screw Set
②	4 5704 210	Rocker Cover
③	4 5761 400	Rocker Support Assembly
③-1	4 5761 410	Rocker Support
③-2	4 5761 600	Rocker Arm Retainer (2pcs.)
④	4 5761 000	Rocker Arm Assembly (1pair)
④-1	4 5761 100	Rocker Arm (1pc.)
④-2	4 5761 200	Tappet Adjusting Screw
⑤	4 5760 020	Valve Assembly (1pair)
⑤-1	4 5760 110	Valve (1pc.)
⑤-2	4 5760 210	Valve Spring (1pc.)
⑤-3	4 5060 309	Valve Spring Seat (1pc.)
⑤-4	4 6160 400	Valve Spring Retainer (2ps.)
⑥	4 4104 100	Cylinder Head
⑦	4 4104 020	Cylinder Head Assembly
⑧	4 5769 200	Exhaust Pipe Lock Nut
⑨	2 1381 950	Insulator
⑩	4 4169 400	Intake Pipe Assembly
⑩-1	2 3081 725	Intake Pipe Retaining Screw (2pcs.)
⑪	2 1381 050	Carburetor Complete (1AB-K6)
⑪-1	2 1015 001	Carburetor Gasket
⑪-2	2 3081 706	Carburetor Retaining Screw (2pcs.)
⑫	2 2714 100	Cylinder Head Gasket
⑬	4 4103 400	Piston Ring
⑭	4 4103 200	Piston
⑮	2 2706 000	Piston Pin
⑯	4 5705 000	Connecting Rod
⑰	4 4103 100	Cylinder Liner
⑱	4 5707 010	Cover Plate
⑲	4 4102 010	Crankshaft
⑲-1	4 5702 100	Crankshaft Spacer
⑳	2 2630 002	Crankshaft Ball Bearing (Rear)
㉑	4 4101 010	Crankcase
㉒	4 5762 100	Thrust Ball (2pcs.)
㉓	4 5762 010	Camshaft
㉔	4 5701 110	Cam Cover
㉕	4 4166 000	Push Rod (2pcs.)
㉖	4 4166 100	Push Rod Cover Assembly (2pcs.)
㉖-1	4 4166 110	Push Rod Cover (1pcs.)
㉖-2	2 4881 824	Push Rod Cover "O"Ring (2pcs.)
㉗	4 5264 000	Cam Follower (2pcs.)
㉘	4 5231 000	Crankshaft Ball Bearing (Front)
㉙	2 3210 007	Propeller Nut
	7 1615 009	Glow Plug Type F
	7 2403 100	Super Air Cleaner 101 (W/3 filter elements)
	7 2403 110	101 Cleaner Body
	7 2403 120	101,102 Filter Element (6pcs.)

Specifications are subject to alteration for improvement without notice.

FS-26S-CX EXPLODED VIEW

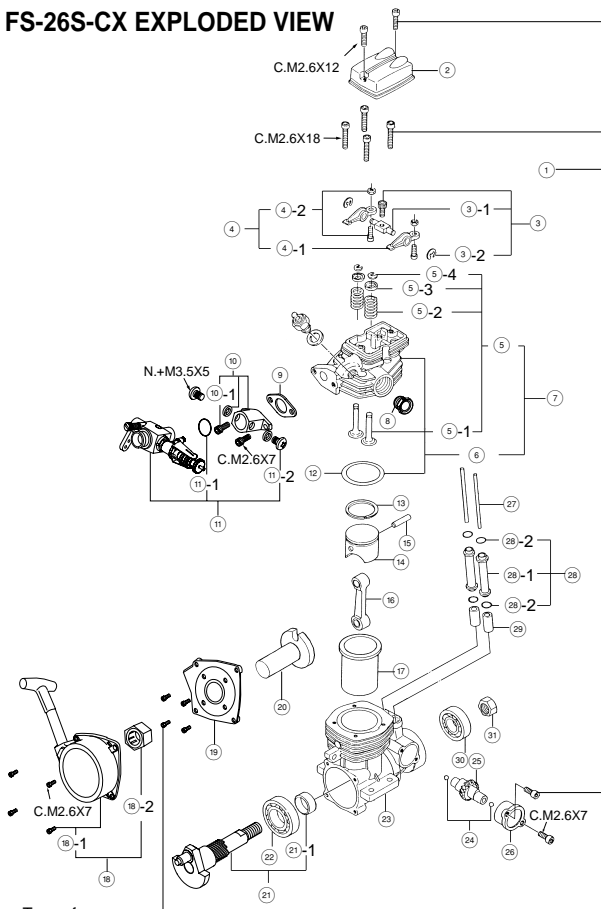

* Type of screw

C...Cap Screw B...Binding Head Screw M...Oval Fillister-Head Screw

F...Flat Head Screw N...Round Head Screw S...Set Screw

No.	Code No.	Description
①	4 4113 000	Screw Set
②	4 5704 210	Rocker Cover
③	4 5761 400	Rocker Support Assembly
③-1	4 5761 410	Rocker Support
③-2	4 5761 600	Rocker Arm Retainer (2pcs.)
④	4 5761 000	Rocker Arm Assembly (1pair)
④-1	4 5761 100	Rocker Arm (1pc.)
④-2	4 5761 200	Tappet Adjusting Screw
⑤	4 5760 020	Valve Assembly (1pair)
⑤-1	4 5760 110	Valve (1pc.)
⑤-2	4 5760 210	Valve Spring (1pc.)
⑤-3	4 5060 309	Valve Spring Seat (1pc.)
⑤-4	4 6160 400	Valve Spring Retainer (2ps.)
⑥	4 4104 100	Cylinder Head
⑦	4 4104 020	Cylinder Head Assembly
⑧	4 5769 200	Exhaust Pipe Lock Nut
⑨	2 1381 950	Insulator
⑩	4 4169 400	Intake Pipe Assembly
⑩-1	2 3081 725	Intake Pipe Retaining Screw (2pcs.)
⑪	2 1381 050	Carburetor Complete (1AB-K6)
⑪-1	2 1015 001	Carburetor Gasket
⑪-2	2 3081 706	Carburetor Retaining Screw (2pcs.)
⑫	2 2714 100	Cylinder Head Gasket
⑬	4 4103 400	Piston Ring
⑭	4 4103 200	Piston
⑮	2 2706 000	Piston Pin
⑯	4 5705 000	Connecting Rod
⑰	4 4103 100	Cylinder Liner
⑱	7 3003 000	No.5 Recoil Starter Assembly
⑱-1	7 3003 100	No.5 Recoil Starter Body
⑱-2	7 3003 200	No.5 One-way Clutch
⑲	4 4121 000	Rear Adaptor
⑳	4 4121 200	Starting Shaft
㉑	4 4102 100	Crankshaft
㉑-1	4 5702 100	Crankshaft Spacer
㉒	2 2630 002	Crankshaft Ball Bearing (Rear)
㉓	4 4101 020	Crankcase
㉔	4 5762 100	Thrust Ball (2pcs.)
㉕	4 5762 010	Camshaft
㉖	4 5701 110	Cam Cover
㉗	4 4166 000	Push Rod (2pcs.)
㉘	4 4166 100	Push Rod Cover Assembly (2pcs.)
㉘-1	4 4166 110	Push Rod Cover (1pcs.)
㉘-2	2 4881 824	Push Rod Cover "O"Ring (2pcs.)
㉙	4 5264 000	Cam Follower (2pcs.)
㉚	4 5231 000	Crankshaft Ball Bearing (Front)
㉛	2 3210 007	Propeller Nut
	7 1615 009	Glow Plug Type F
	7 2403 100	Super Air Cleaner 101(W/3 filter elements)
	7 2403 110	101 Cleaner Body
	7 2403 120	101,102 Filter Element (6pcs.)

Specifications are subject to alteration for improvement without notice.

CARBURETTOR EXPLODED VIEW & PARTS LIST

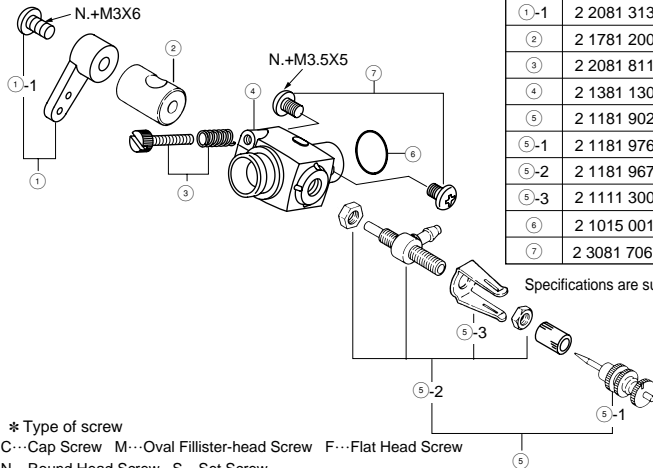

No.	Code No.	Description
①	2 2081 408	Throttle Lever Assembly
①-1	2 2081 313	Throttle Lever Retaining Screw
②	2 1781 200	Carburettor Rotor
③	2 2081 811	Throttle Stop Screw
④	2 1381 130	Carburettor Body
⑤	2 1181 902	Needle-valve Assembly
⑤-1	2 1181 976	Needle
⑤-2	2 1181 967	Nozzle Assembly
⑤-3	2 1111 300	Ratchet Spring
⑥	2 1015 001	Carburettor Rubber Gasket
⑦	2 3081 706	Carburettor Retaining Screw (2pcs.)

Specifications are subject to alteration for improvement without notice.

FS-26S-C THREE VIEW DRAWING

Specification

Displacement	4.41cc (0.269cu.in.)
Bore	18.5mm (0.728in.)
Stroke	16.4mm (0.648in.)
Practical R.P.M.	2,000~22,000r.p.m.
Power output	0.5bhp/17,000r.p.m.
Weight	242.5g (8.56oz.)

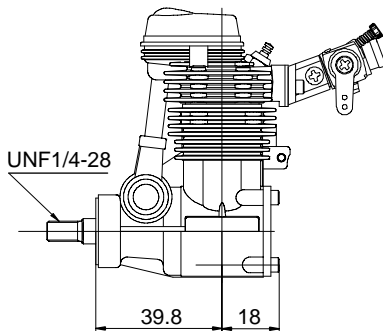
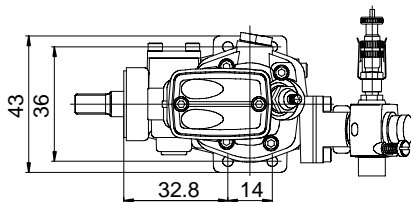
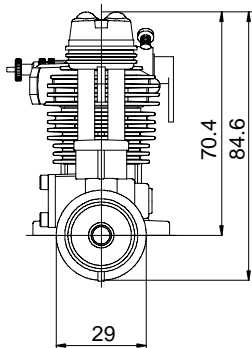

Dimension(mm)

FS-26S-CX THREE VIEW DRAWING

Dimension(mm)

Specification

Displacement	4.41cc (0.269cu.in.)
Bore	18.5mm (0.728in.)
Stroke	16.4mm (0.648in.)
Practical R.P.M.	2,000~22,000r.p.m.
Power output	0.5bhp/17,000r.p.m.
Weight	308g (10.87oz.)

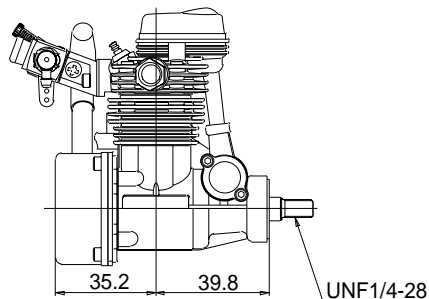
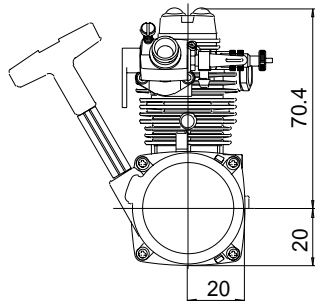
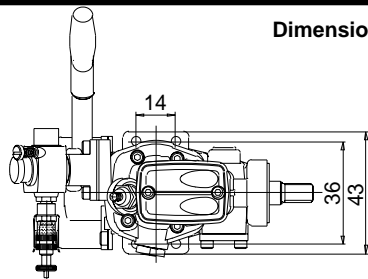



O.S. ENGINES MFG.CO.,LTD.

6-15 3-Chome Imagawa Higashisumiyoshi-ku
Osaka 546-0003, Japan TEL. (06) 6702-0225

FAX. (06) 6704-2722