

HobbyZone® products are distributed exclusively by
Horizon Hobby, Inc.
4105 Fieldstone Road
Champaign, IL 61822
©2005 Horizon Hobby, Inc.
8072

radio control sports®
hobbyzonesports.com

HBZ7015



FIREBIRD Freedom

Instruction Manual



ACT
ANTI-CRASH
TECHNOLOGY

RTF
READY-TO-FLY

X
PORT

Z1



Welcome
to the World of

hobbyzone[®]
radio control sports[®]

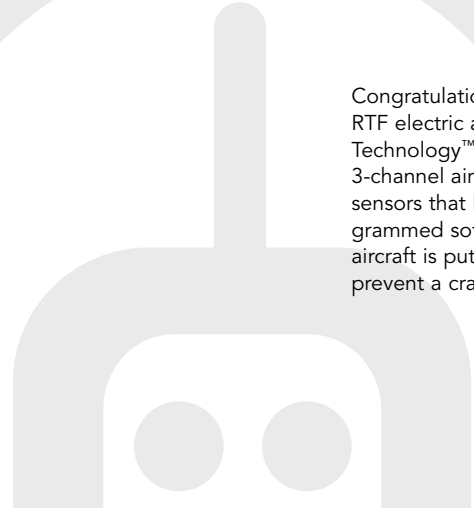

Congratulations on your purchase of the HobbyZone[®] Firebird Freedom[™] RTF electric airplane. Your Firebird Freedom uses advanced Anti-Crash Technology[™] (ACT) that allows you to safely train with a fully proportional 3-channel aircraft and radio system. The Firebird Freedom has built-in sensors that look for the sky and horizon, and thanks to the specially programmed software, it can temporarily "take over" in the event that your aircraft is put in danger from incorrect transmitter input. This will help to prevent a crash, and keep you in the air!

Once you are more experienced and no longer need the training software, you can simply turn off ACT with a flip of the transmitter switch. When this is done, you will have full control, at all times, allowing you to perform exciting maneuvers, such as loops and spirals. You can also add exciting X-Port[™] accessories, such as the Sonic Combat Module[™] for aerial combat and the Aerial Drop Module[™] for dropping bombs.

Your Firebird Freedom comes complete with everything you need, all in one box, to get you in the air and flying. A video compact disc (VCD) is also included to give you some helpful hints before you take to the sky.

Please read this instruction manual thoroughly and watch the VCD prior to flying for the first time. This will greatly add to your flight experience and help to ensure success on your first flight.

Crash damage is not covered under the warranty.

Be sure to read the warranty on page 30 and "Warnings and Safety" on page 27 before you proceed to Step 1.

Transmitter

1. Remove the transmitter back cover by pushing down with thumbs, as indicated by the arrows.
2. Install the included "AA" batteries. Use eight fresh 1.5V "AA" batteries only.
3. Be sure to observe proper polarity when installing the batteries, and then replace the cover.
4. To test, switch on the transmitter. The LED should glow brightly.
5. Replace the batteries when you hear the low battery alarm (beeping sound).

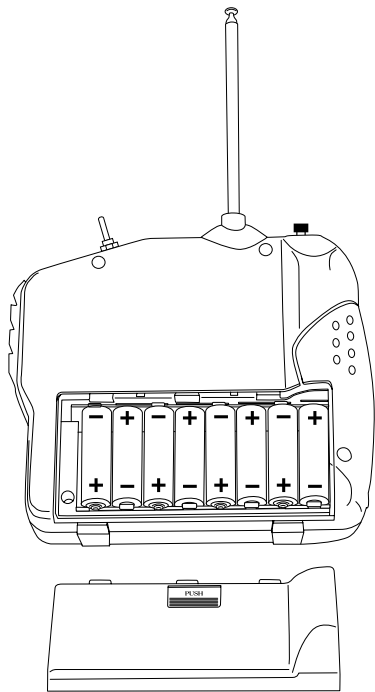
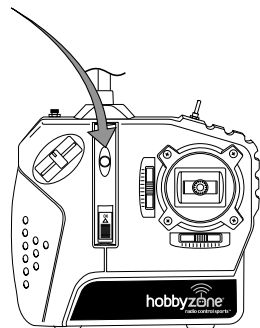

Motor Test and Battery Discharging

Adult Supervision Required

WARNING: Keep everything clear of the propeller AT ALL TIMES and hold the plane securely. A moving propeller can cause severe injury.

1. Turn on transmitter.
2. Install the flight battery into the fuselage and plug it into the connector.
3. Move the slide throttle back all the way to arm it and then slide it full forward. The prop should spin at a high speed when you move the throttle forward. Keep everything clear of the propeller until it stops spinning. This is the indicator that the battery is fully discharged. If the motor does not run, it likely means that the battery is already completely discharged, so you can proceed to the section for charging the battery.
4. After you have ensured the motor functions correctly, and the battery has been discharged, unplug the flight battery and then turn off the transmitter.

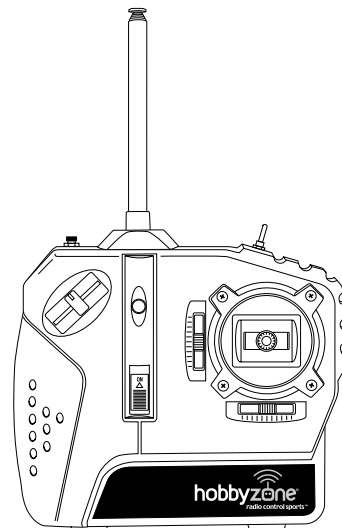

Always make sure the transmitter is on when the flight battery is plugged in!

Charging the Aircraft Battery

Variable rate DC peak charger features:

- Variable charge rate from 0.3–1.2A
- Trickle charge
- LED charge indicator
- Charges 4- to 7-cell Ni-Cd and Ni-MH battery packs

1. Select a charge rate of 1.2 amps for the included 8.4V 1000mAh Ni-MH battery.
2. Attach the battery to the charger.
3. Plug the charger into the 12V power outlet of an automobile. An adult should supervise children while they are charging the battery pack to avoid injury or possible fire. **ALWAYS PLACE BATTERIES ON A HEAT-RESISTANT SURFACE WHILE CHARGING.**
4. The LED indicator will blink on and off while the battery is fast charging.
5. When the LED indicator glows solidly, it has fully peaked and is trickle charging.
6. We recommend peak charging your flight battery right before flying (within a few hours).

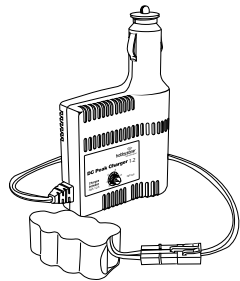

The charger supplied with your Firebird Freedom™ is a variable rate DC peak charger. This charger will allow you to safely and fully charge your flight battery along with other 4- to 7-cell HobbyZone battery packs:

Battery	Maximum Charge Rate
4.8V 600mAh Ni-MH (requires HBZ1027)	0.8 amps
6.0V 600mAh Ni-MH (requires HBZ1027)	0.8 amps
6.0V 300mAh Ni-MH (requires HBZ1027)	0.4 amps
7.2V 1000mAh Ni-MH	1.2 amps

Note: If you exceed the maximum charge rate recommended above, permanent damage can occur to both your charger and battery pack, and a fire may result.

Wing and Landing Gear Attachment

Attaching the Landing Gear

1. Locate the landing gear within the box.
2. Simply insert the landing gear into the slot on the bottom of fuselage.

Note: If you are only flying over grass and intend to land on the grass, and you do not have an X-Port™ accessory attached, landing gear is not required.

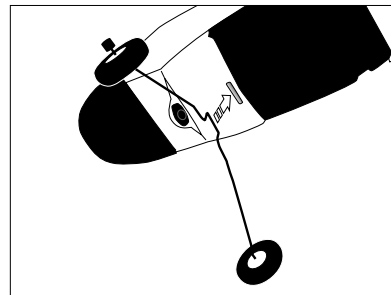

Attaching the Wings

1. Locate the wing halves and wing spar.
2. Slide the spar carefully into one wing half.
3. Slide the wing and spar into the side of fuselage, as shown in the image on the right.
4. Slide the remaining wing half onto the spar that is sticking out the side of the fuselage.
5. Make sure that both wing halves are on securely and are pushed firmly into the wing cavity of the fuselage.

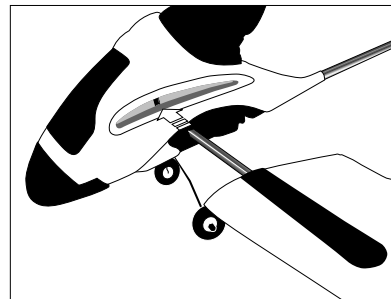

Tail Control Test

1. Make sure slide throttle is "off" and then turn on transmitter.
2. Install and plug in the flight battery.
3. Move the stick side to side while observing that the tail flaps are moving as shown.
4. Move the stick up and down while observing that the tail flaps are moving as shown.
5. The small levers under and to the side of the stick are the trim levers and are used to adjust the "neutral" point of your control stick. These should be centered prior to performing the test.
6. If you find that each flap is not level with the rest of the tail surface when the trim levers are centered, adjust the control surfaces so they are level. To do this, loosen the round spool on the control surface. Then, move the control surface back to neutral and re-tighten the spool. (See page 32 for more details).

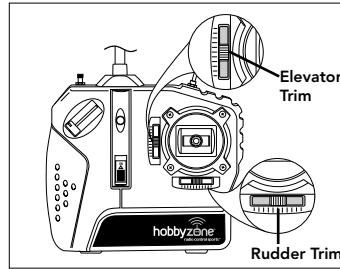
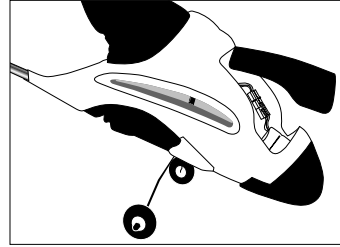

WARNING: Keep everything clear of the propeller when you conduct the tail control test in the event that you accidentally turn on the motor.

Tail Control Test (continued)

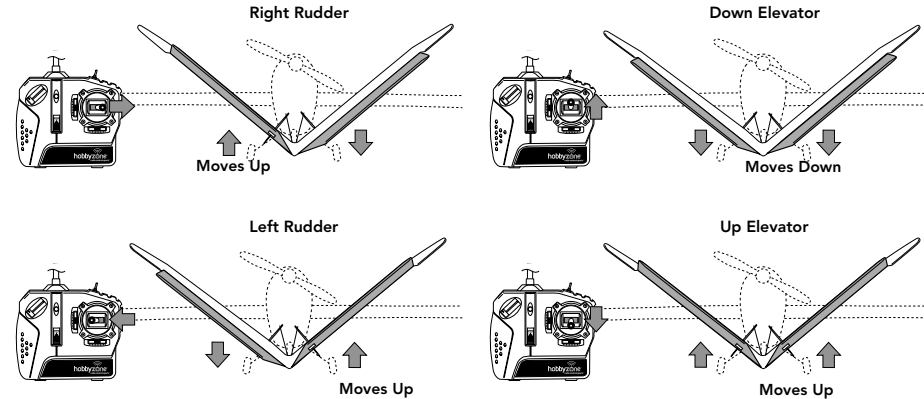

View from Rear

Choose a Large, Open Grass Field

In order to have the most success, and to protect property and your Firebird Freedom™ from any damage, it is very important to select a place to fly that is very open. The site should:

- Have a minimum of 300 feet of clear space in all directions
- Be clear of pedestrians
- Be free of trees or buildings that could interfere with your sightline, or power lines that could entangle your airplane
- Be clear of automobiles and other property that could be damaged by your plane if you have problems coming in for a landing.

Remember, your Firebird Freedom can fly at speeds in excess of 30 mph, so it covers ground fast. Plan on using more space than you think you need, especially with the first flights that you make.

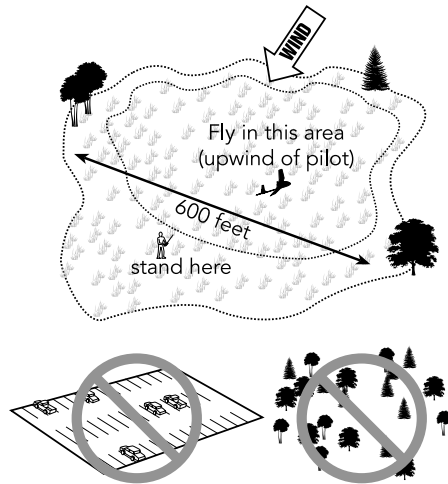

Choose a Calm Day

We know you want to have fun and fly your Firebird Freedom.™ However, flying in too much wind can place your airplane in jeopardy. On your first flight, make sure the winds are no stronger than 7 mph.

To check wind conditions:

1. Tie the included red ribbon to the end of the transmitter antenna.
2. Hold the transmitter so that the antenna is parallel to the ground.

Always position yourself so that when you are flying, the airplane is UPWIND of you. Never let the airplane come too far downwind where it can be carried farther and farther away from you and lost. Additionally, the winds are stronger at higher altitudes. Do not climb too high, or you could lose control of your airplane.

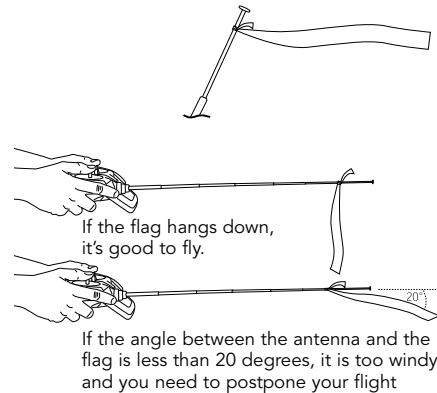

HINT: In many places, you will find that the winds are the most calm in the mornings (shortly after sunrise) and evenings (about an hour prior to sunset). You may want to prepare and fly your first flights during those times. Flying in too much wind is by far the number one reason for crashes/lost planes.

Range Test

Prior to your first flight you will need to do a range test. Two people are needed to do this—one to hold the transmitter and one to hold the airplane.

1. One person holds the transmitter while the other person walks 100 paces away with the airplane.
2. Be sure the throttle slider is in the "OFF" position.
2. Extend the transmitter antenna completely and turn on the transmitter.
3. Plug in the airplane battery and close the hatch cover.
4. As soon as the throttle is advanced, the props should spin quickly.
5. As the first person moves both of the transmitter controls in all directions, the other person watches to be sure the airplane's motor and tail controls operate smoothly.

If your plane does not range test correctly, do not fly! Call Horizon Hobby Product Support Staff toll-free at 1-877-504-0233 for directions on how to proceed.

WARNING: The person holding the airplane should hold it so that the propeller does not come near any part of their body.

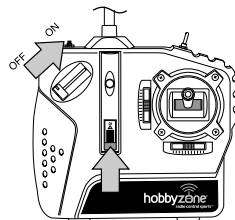
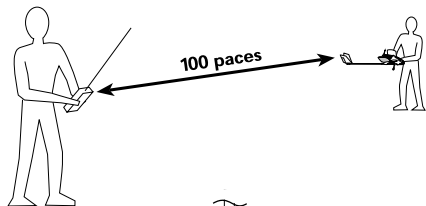

Anti-Crash Technology (ACT)

Your Firebird Freedom™ comes equipped with exclusive Anti-Crash Technology.™ This software helps prevent crashes due to over-control by pilots. The sensors included in the fuselage "see" the horizon. One sensor is above the canopy and faces forward. The other is at the bottom of the fuselage and faces backward.

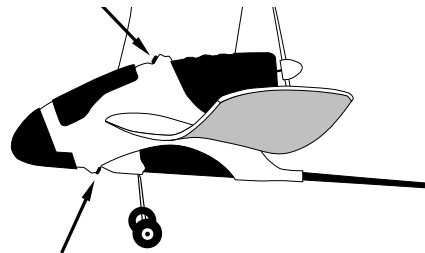

The electronic system connected to them knows the airplane should not be allowed to enter a steep dive. If you give transmitter input that causes the plane to enter into a spiral dive that may threaten your aircraft, the ACT software will override your input to

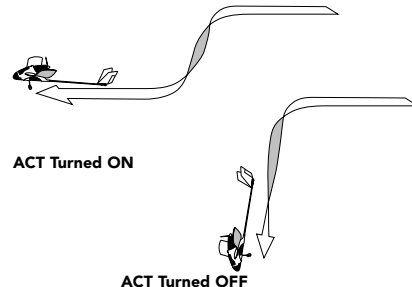

help prevent the aircraft from crashing to the ground. The ACT will intervene for you when the aircraft is in jeopardy by reducing throttle and adding some up elevator, as well. This causes the nose of the airplane to pull up, thereby helping to prevent your Firebird Freedom from crashing, provided there is enough altitude for recovery. The ACT software will only interrupt flight in extreme situations, allowing you to enjoy as much control of the airplane as you need.

Anti-Crash Technology (ACT)

The Firebird Freedom's ACT™ software will help prevent you from crashing into the ground. If you enter a severe dive while flying with ACT engaged, you will notice the following things take place:

- You will hear the motor speed reduce as the ACT programming overrides your input. This slows the descent of the aircraft to help prevent a crash.
- The ACT software will give up elevator input to the aircraft's electronics to help pull the plane out of a dive.
- There will be a noticeable change in the movement of the aircraft if you give it extreme input, and the diameter of turns will be larger.
- The nose of the airplane will only be allowed to reach a limited angle, and then will rise up in order to prevent too much speed from being generated.
- Once the ACT software has taken over, you will not be able to give control input until you have **released the steering stick, allowing it to return to neutral.**

Remember, the purpose of ACT is to help you to learn to fly properly and smoothly. When ACT is engaged, and overrides your input, it means that you have placed your aircraft in jeopardy. Keeping the stick more in the middle, and less in the corners, will allow you to fly more smoothly and prevent ACT from engaging. ACT should be the backup for you. The key is to learn to make minor movements on the controls because the transmitter is proportional and is sensitive to movements of the control stick. Once you have gained more experience, and feel more comfortable flying, you can turn the ACT software off to enter "Expert Mode." It is possible to change flight modes in the air, but sufficient altitude is required.

To turn ACT off:

Move the switch on top of the transmitter to the appropriate position.

Anti-Crash Technology (ACT) Flying Tips

- Don't fly at too low of an altitude and expect the ACT to save your Firebird Freedom.™ You must be at an altitude of at least 150 ft. for the software to be able to help prevent crashes due to incorrect transmitter input.
- Even when flying with ACT on, if you feel that your airplane is beginning to enter a steep dive, you may then apply some up elevator to aid recovery as well as reduce throttle.
- Because the Freedom's ACT uses sensors to activate the protective software, there could be times when the sensors could be fooled. This may be especially true when flying in very bright sunshine and/or when the sun is close to the horizon.
- Don't fly over water, light sand, snow, ice, asphalt or anything else that can reflect light and temporarily fool the sensors.
- Don't fly in too small of an area, as the ACT technology will not help to prevent crashes into trees, buildings, or other obstacles.
- Make several successful flights (including soft landings) prior to attempting to fly without the aid of the ACT software.
- Remember, it is possible to switch ACT on and off in flight, but make sure you have sufficient altitude, and the plane is in level controlled flight.
- Do not let the airplane drift too far down wind from you, as it can become very difficult to get back to you.

Using Elevator

Your Firebird Freedom™ is equipped with a third channel for pitch control (elevator). Pulling back on the stick provides UP elevator that allows for shorter runway takeoffs, better flares for landing, a better climb rate, and more effective turns. However, giving too much UP elevator (pulling back on the stick) will cause the airplane to enter a stall, especially at slower speeds.

Just after a stall occurs, the nose of the airplane will go down, and the airplane will begin to enter a dive. To recover from a stall, pull the stick back slowly (UP elevator) once the nose of the airplane goes down and the plane has built up airspeed. Pulling back slowly on the stick will put the nose up, and cause the plane to exit the stall to straight and level flight. Be careful, as pulling back too quickly or too far will once again cause the airplane to stall.

Hand Launch

On first flights, it is a good idea to have a second person, ideally an adult, help you launch your airplane. This will allow the pilot to focus entirely on the transmitter input.

1. Make sure the battery is fully charged.
2. Make sure that no one who is flying or preparing to fly is on the same channel, within approximately ½ mile (805 meters), that you are on. When you are confident of this, turn on the transmitter.
3. Install and plug in the flight battery.
4. If you are launching and flying the airplane, place the transmitter in your left hand and grab hold of your airplane with your right hand. Use caution, and advance the throttle all the way up so that it is full on.
5. Take a few steps and launch the model DIRECTLY into the wind, while keeping the airplane and its wings level with the ground. Use medium force.

WARNING: Keep the spinning propeller away from your hair, head, and hands or injury may occur.

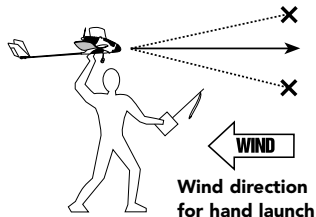

6. Allow the plane to climb steadily at full throttle into the wind until you have achieved an altitude of 150 to 200 feet (46 to 61 meters). You will not need to use elevator in order for your plane to climb. A few clicks down on elevator trim should allow steady climb.

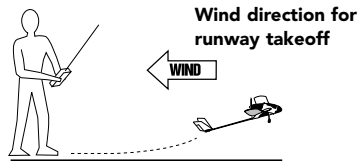

Runway Takeoff (ROG)

Not recommended for inexperienced pilots.

1. Make sure your landing gear is properly installed and is securely in the slot on the fuselage before you attempt takeoff.
2. Stand behind the Firebird Freedom™ and point it directly into the wind on smooth asphalt or concrete.
3. Apply full power and adjust the right control stick as necessary to keep the Firebird Freedom headed directly into the wind.
4. If the battery is fully charged, the Firebird Freedom should lift off the ground in approximately 40 feet. Apply some UP elevator by pulling the stick back, and the plane will lift off of the ground in a shorter distance. Remember, only a small amount of UP is needed. Too much will result in a stall after the plane has left the ground.

Flying

1. After launching your Firebird Freedom™, it will begin climbing at full throttle. With the throttle all the way on, your Firebird Freedom should climb without any elevator input.
2. Make right- and left-hand adjustments to keep your airplane heading **directly into the wind**. Do not attempt a turn until you have reached a minimum of 50–100 feet of altitude. That's about as tall as a 4- to 8-story building. It is hard to determine altitude when you're in a wide and open space outside, so the best rule is to err on the side of caution and allow yourself sufficient altitude when flying.
3. Control range is 2500 feet. Don't let the airplane get too far away. Keep the aircraft UPWIND from you. Failure to do this could result in a flyaway! Remember – the wind is stronger as your plane gets higher in the air. It's okay to fly higher, just be cautious and watch how your plane reacts to the wind. Most of the time, you can fly at higher altitudes at half throttle.

This is great for smooth easy flying when you're first learning to fly, and conserves battery power.

4. When you have reached higher altitudes and want to practice using the elevator, begin with small and smooth inputs to the transmitter, as very little input is required to get the plane to turn, climb, or descend.
5. Avoid long vertical dives, with power on or off, as it can cause a lot of stress on the airplane.

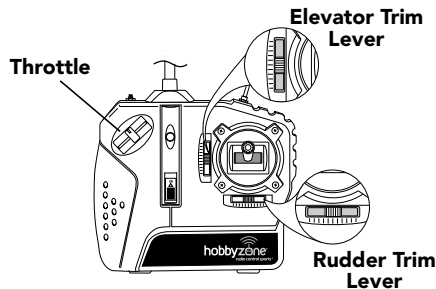

Flying (continued)

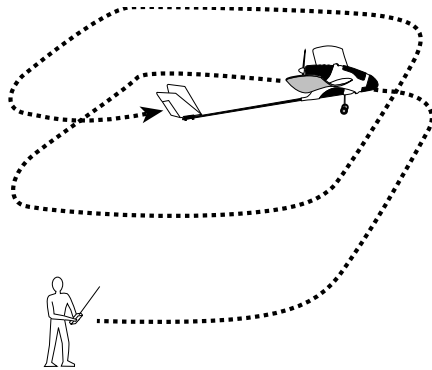

Sharp Turns:

Move the stick in the direction you want to turn and add a bit of UP elevator at the same time (pull back on stick). The plane will make a sharper banking turn.

Rudder Trim:

If the Firebird Freedom™ seems to drift in one direction when the control stick is in the neutral (centered) position, gradually move the rudder trim lever below the control stick in the OPPOSITE direction of the drift. Adjust until the plane flies straight with the control stick at neutral.

Elevator Trim:

If the model always "hunts" up or down, use the trim lever to the left of the stick to correct this problem. If it hunts up, slide the left trim lever up one notch at a time until it flies level. If it hunts down, slide the left trim lever down one notch at a time until it flies level. The model should fly straight with the stick at neutral. Your Firebird Freedom should have a steady climb at full throttle when it is trimmed properly.

Throttle Adjustment

1. When launching, the throttle should be full on.
2. Once you have achieved the altitude where you want to fly you can reduce throttle to about 50% for cruising. This will also allow for longer flights.
3. If you want to reduce altitude, reduce throttle to less than 50%.
4. To increase altitude again, increase throttle to more than 50%.

Note: If you're flying with the motor off, or at a low speed, allow the Firebird Freedom™ a bit more area for turns.

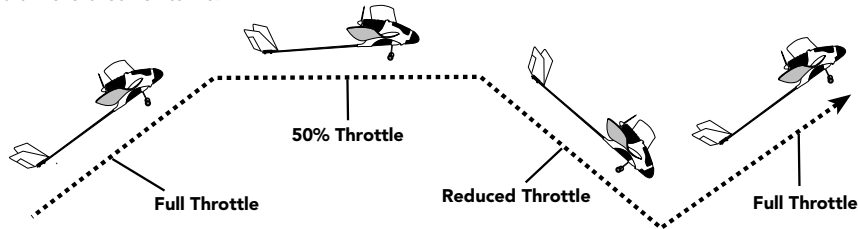

SUCCESS TIP: Your Firebird Freedom's transmitter has a throttle slider that gives power to the motor. It has proportional control, meaning you can advance the motor as much or little as needed in flight. In order to have the most success, it is important to operate the throttle slider smoothly, as you should the steering and elevator stick.

Landing

When you notice that your Firebird Freedom™ no longer climbs well under full power, normally after about 10–12 minutes, the battery is getting low and it is time to land. Line the airplane up directly into the wind toward the desired landing spot. At about 10–15 feet of altitude, reduce the throttle gradually until it is completely shut off. Your Firebird Freedom will glide in for a landing.

Auto Cutoff: When the battery gets low enough, this feature will automatically shut off the motor and save enough battery power to maintain control of the tail so you can land correctly and safely. If the motor cuts off, prepare to land immediately. If you are gliding down and have some time to rest the battery, you may re-arm the motor by moving the throttle slider back to off and then advancing it again. This will only allow the motor to run briefly, and may allow you to better adjust your landing. **DO NOT** re-arm more than once.

WARNING: Do not attempt to catch the airplane or injury may result. Turn the motor off prior to touchdown in order to prevent damage to the wing and/or propeller.

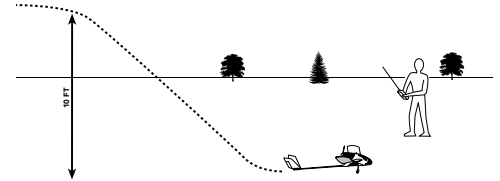

Reduce power at 10 feet

EXPERT TIP: As you get more experienced at flying, try adding a bit of UP elevator (pull back on stick) just before touchdown to "flare" the plane. With some practice, your landings will be smooth and on target.

Making Adjustments: Plane Turns to the Left or Right

If you notice that your airplane wants to turn to either the left or right when the control stick is centered, some adjustments are needed as the control surfaces may not be at neutral. In most cases, a few clicks in the needed direction (right or left) on the trim lever will correct the problem. If you need even more adjustment do the following:

1. With the transmitter on, and flight battery plugged in, place both trim levers on the transmitter at the neutral position (center).
2. Loosen the spool on the control surface.
3. Move the control surface back to neutral, or even with the rest of the tail, and re-tighten the spool.

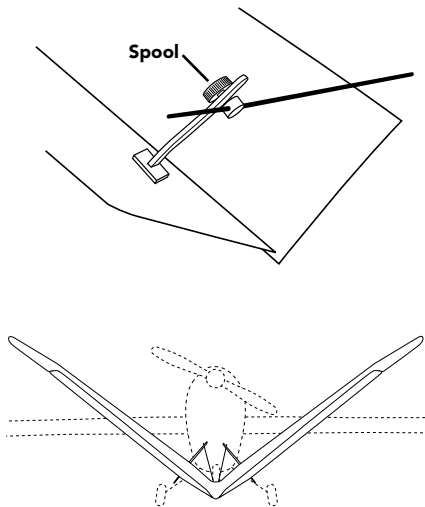

Control surfaces neutral after correction

Making Adjustments: Plane Turns to the Left or Right

If you are certain the control surfaces are at neutral and the plane still "wanders" to the left:

1. Adjust the tail (see below) so that the left tail control surface is $1/16''$ above the rest of the tail.
2. Test fly.
3. If it is still flying on its own to the left, repeat the above procedure until it flies straight.

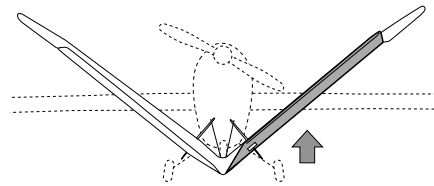
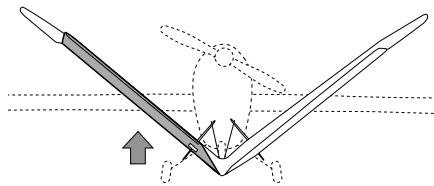

IMPORTANT: If there is a bend (even a small one) in the tail or wing or a tear near the flap areas, it will be impossible to have correct flight control. Replace the damaged part immediately!

If the plane still "wanders" to the right:

1. Adjust the tail so that the right tail control surface is $1/16''$ above the rest of the tail.
2. Test fly.
3. If it is still flying on its own to the right, repeat the above procedure until it flies straight.

Adjusting the Climb Rate

If your Firebird Freedom™ does not climb fast enough when at full throttle and with a full charged battery pack, you can adjust the climb rate by:

1. Tightening the front screw one full turn and loosening the back screw one full turn.
2. Test flying.
3. Repeat the above procedure until your plane climbs adequately under full power.

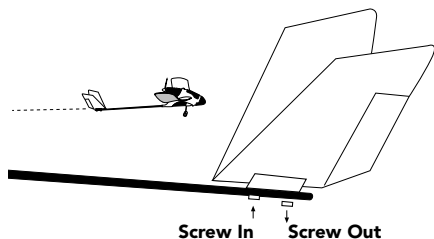

If your Firebird Freedom climbs too fast at full throttle by climbing at a steep angle, stalling and keeps repeating climbing sharply and stalling, do the following:

1. Loosen the front tail screw one full turn and tighten the back tail screw one full turn.
2. Test fly.
3. Repeat the above procedure, if necessary, until your Firebird Freedom climbs at a steady rate.

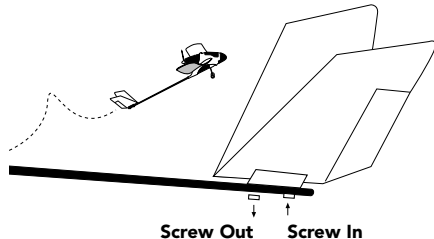

Aerobatic Flight

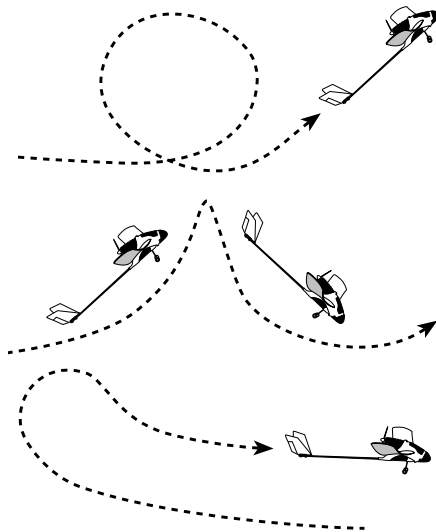

Your Firebird Freedom™ comes out of the box with the controls set for beginning pilots, with the pushrod attached in the outer holes of the control surfaces. By adjusting the pushrods so they are attached in the holes on the tail that are closer to the control surfaces, you will give your Firebird Freedom more control response for more aerobatic maneuvers, such as loops and tail slides.

CAUTION: This should not be done until you have gained more experience at flying and have flown for some time successfully with the ACT™ software turned off.

If a Crash Occurs

If you happen to crash and part of the foam wing or tail breaks, it can be repaired using packing tape to cover missing pieces.

If damage is severe or if the wing or tail is bent, replace damaged parts immediately. See page 32 for a complete replacement parts list.

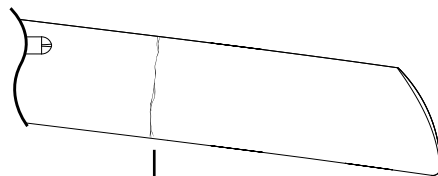
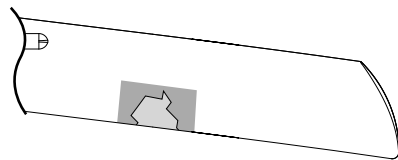

Replace wing immediately

Warnings and Safety Checklist

1. Read and follow this manual and included video CD completely, observing all instructions and safety directions. If you do not do this, serious injury and damage can occur. **Think safety first.**
2. Keep propeller away from all body parts at all times! Beware of loose clothing or hair becoming entangled in the propeller.
3. Never fly when it is too windy or you may lose control of the airplane. Never fly near people, vehicles, train tracks, buildings, power lines, water, hard surfaces, or trees, and never attempt to catch the Firebird Freedom.™
4. Adult supervision is recommended for ages 12 and under.
5. Only use a battery charger intended for use with the Firebird Freedom battery. We recommend using the charger that comes with your airplane. Never leave the charger unattended while charging! During charging, place the battery and charger on a heat-resistant surface. Do not place them on carpet or upholstery.
6. Never cut into the battery charger or airplane wires, or serious injury can occur. Causing the battery to short out (crossing negative and positive bare wires) can cause a fire, serious injury and damage.
7. Hold the plane securely, and keep all body parts away from the propeller at all times.
8. After you have finished flying, or at any time you have the radio system on, ALWAYS unplug the battery prior to turning the transmitter off. ALWAYS turn on the transmitter prior to plugging flight battery in.
9. Never fly on the same frequency as another RC vehicle in your area. Doing so will cause you, or the other person, to lose control of the plane.

Troubleshooting

PROBLEM	POSSIBLE CAUSE	SOLUTION
Unit does not operate	<ol style="list-style-type: none"> 1. Transmitter "AA" batteries are depleted or installed incorrectly as indicated by a dim or unlit LED on the transmitter or the low battery alarm 2. No electrical connection 3. Aircraft battery is not charged 4. Crash has damaged the radio inside the fuselage 	<ol style="list-style-type: none"> 1. Check polarity installation or replace with fresh "AA" batteries 2. Push connectors together until they click 3. Fully charge the battery 4. Replace the fuselage
Aircraft keeps turning in one direction	<ol style="list-style-type: none"> 1. Tail flaps need adjustment 	<ol style="list-style-type: none"> 1. Adjust stick trim lever (see page 19) or adjust tail flap position (see pages 22-23)
Aircraft is difficult to control	<ol style="list-style-type: none"> 1. Tail flaps aren't adjusted properly 2. Wing or tail is damaged 	<ol style="list-style-type: none"> 1. Adjust tail flaps (see pages 22-23) 2. Repair or replace tail
Aircraft keeps pitching up steeply	<ol style="list-style-type: none"> 1. Tail incidence needs adjustment 2. Wind is too gusty or strong 	<ol style="list-style-type: none"> 1. Adjust tail screw (see page 24) 2. Postpone flying until wind is more calm
Aircraft won't climb	<ol style="list-style-type: none"> 1. Battery isn't fully charged 2. Tail needs adjustment 	<ol style="list-style-type: none"> 1. Charge battery shortly before flying 2. Adjust tail screws (see page 24)

Success Tips

1. Do not fly in winds over 7 mph, especially during first flights. Flying in too much wind is by far the number one reason for crashes and flyaways.
2. Choose the flying area carefully. A grassy field or soft ground that is about 600 feet in diameter is optimum. It's also best to fly in an area with very few or no trees.
3. ALWAYS fly the airplane UPWIND! Never allow your Firebird Freedom™ to fly too far down wind, as it will get farther and farther away from you. If you find that the plane has gotten down wind, reduce throttle and point the nose directly into the wind to bring it back closer to you.
4. Wear sunglasses on sunny days.
5. Avoid flying directly overhead.
6. Always make sure the flight battery is fully charged immediately prior to flying.
7. Do not attempt maneuvers beyond your abilities, especially with the ACT™ programming off.

To learn more about flying RC model airplanes, locate your nearest AMA club, learn the AMA safety code and frequency guidelines, and much more, we highly recommend that you contact:

The Academy of Model Aeronautics
 5161 East Memorial Drive
 Muncie, Indiana 47302
 Toll-Free (800) 435-9262
www.modelaircraft.org

Warranty and Follow-Up Procedures

Horizon Hobby, Inc. guarantees that your HobbyZone® Firebird Freedom™ will be free from defects in material and workmanship at the date of purchase. This warranty does not cover any component parts, or damage by use or modification. In no case shall Horizon Hobby's liability exceed the original purchase cost of this item. Further, Horizon Hobby reserves the right to change or modify this warranty without notice.

This warranty covers only those products purchased from an authorized Horizon Hobby dealer. Third party transactions are not covered by this warranty. Proof of purchase is required for all warranty claims. Due to the nature and operation of your Firebird Freedom, the warranty does not extend beyond the initial pre-use testing. Carefully check the parts and operation of your airplane and its components BEFORE your first use. If you discover defects during pre-use testing, please call our Product Support Team toll-free at 877-504-0233 for technical support.

In that Horizon Hobby has no control over the final assembly, or material used for final assembly, no liability shall be assumed nor accepted for any damage resulting from use by the user of the final user-assembled product. By the act of using the product the user assembles, the user accepts all resulting liability. Please note that once assembly has been started, the user must contact Horizon Hobby, Inc. directly regarding any warranty questions. Please do not contact a local hobby shop regarding warranty issues. This will enable Horizon to better answer questions and provide service in the event warranty assistance is needed.

Horizon Hobby, Inc. reserves the right to inspect any and all equipment involved in a warranty claim. Repair or replacement decisions are at the sole discretion of Horizon Hobby, Inc. Collateral damage is not covered under this warranty. If you, as the buyer or owner, are not prepared to accept the liability associated with the use of this product, you are advised to return it immediately in new and unused condition to the place of purchase.

If you have any questions concerning your HobbyZone product, please contact our Product Support staff toll-free at 1-877-504-0233.

If your Firebird Freedom™ requires inspection, please follow these steps in order to return it to us:

1. Call our Product Support team for return authorization.
2. Use the "Service and Repair Checklist" from www.horizonhobby.com under the support tab or write a detailed letter that includes:
 - Your name, address, home phone number, and daytime phone number;
 - A list of the products being shipped for inspection or repair;
 - A detailed account of the type of problems you are incurring; and
 - The payment method you wish to use for any purchases or charges, including credit card type, number, expiration date and your name as it appears on the card.
3. Submit proof of purchase, including purchase date and retailer information.

4. Make sure that the batteries are unplugged and removed. Please use packing material to separate them from product.
5. Pack all components and accessories in the original box, and then pack it in a sturdy box with packing materials for safe shipping.
6. For inspection and/or repair, please ship your product to:

Horizon Service Center
Attn: HobbyZone Department
4105 Fieldstone Road
Champaign, IL 61822

We suggest you ship your product back to us via a carrier that provides package tracking and/or signature required. Horizon Hobby, Inc. is only responsible for product once it arrives and is accepted at our facility. Most carriers require optional insurance to cover damage or loss in transit, so please consider this when shipping merchandise.

Replacement and Optional Parts

Keep your Firebird Freedom™ in the air! Spare parts are available from your dealer or from Horizon Hobby direct (www.horizonhobby.com). Please check with your dealer first—by supporting your dealer, they'll be there when you need them. To locate your local dealer, go to www.hobbyzonesports.com.

PART#	DESCRIPTION	MSRP	PART#	DESCRIPTION	MSRP
HBZ7000	Freedom 3-Channel RTF	\$169.99	HBZ7071	Transmitter: CH1, 26.995	\$32.99
HBZ2016	Landing Gear	\$3.99	HBZ7072	Transmitter: CH2, 27.045	\$32.99
HBZ7010	Decal Sheet	\$2.99	HBZ7073	Transmitter: CH3, 27.095	\$32.99
HBZ7015	Instruction Manual	\$0.99	HBZ7074	Transmitter: CH4, 27.145	\$32.99
HBZ7016	Instruction Video	\$7.99	HBZ7075	Transmitter: CH5, 27.195	\$32.99
HBZ7017	Canopy Cover with Hardware	\$3.99	HBZ7076	Transmitter: CH6, 27.255	\$32.99
HBZ7018	Black Nose Piece	\$1.69	HBZ7085	Bare Fuselage (without Receiver)	\$19.99
HBZ7020	Wing with Spar	\$14.99	HBZ1013	8.4V 1000mAh Ni-MH Battery	\$27.99
HBZ7021	Wing Spar	\$2.99	HBZ1026	DC Peak Charger (1.2 Amp)	\$19.99
HBZ7031	Tail with Accessories	\$9.99	HBZ1058	Transmitter Antenna	\$4.99
HBZ7035	Tail Horn and Keeper (2)	\$0.89	HBZ2017	Tail Wheel	\$1.50
HBZ7039	Tail V-Brace	\$1.49	HBZ2004	Propeller	\$2.99
HBZ7040	Tail Screws (2)	\$0.99	HBZ6057	Transmitter Battery Cover	\$2.50
HBZ7041	Pushrods & Locking Screws (2)	\$1.69			
HBZ7061	Fuselage: CH1, 26.995	\$59.99			
HBZ7062	Fuselage: CH2, 27.045	\$59.99			
HBZ7063	Fuselage: CH3, 27.095	\$59.99			
HBZ7064	Fuselage: CH4, 27.145	\$59.99			
HBZ7065	Fuselage: CH5, 27.195	\$59.99			
HBZ7066	Fuselage: CH6, 27.255	\$59.99			

Replacement and Optional Parts (continued)

X-port Accessories

Your Firebird Freedom™ comes equipped with the ability to add to the excitement of flying. HobbyZone's exclusive X-Port™ technology allows for such things as air-to-air combat, dropping bombs, and even night flight. These items (sold separately) instantly add fun and excitement to X-Port-equipped aircraft.

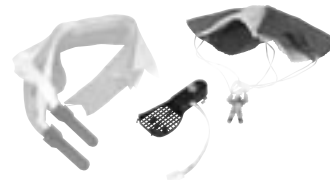

Parachute drops and streamer bombs are included with the **Aerial Drop Module™ (HBZ6023)**. See who can come the closest to a selected target site, or simply have fun watching the parachutists fall slowly back to the earth with the easy-to-use release mechanism of the electro magnetic latch that is released via the transmitter.



Rule the air with the **Sonic Combat Module (HBZ4020)**. You can take on other X-Port™ equipped aircraft by attaching this to your aircraft and shooting down your buddy's aircraft. When you "hit" his/her aircraft, a high-pitched sound can be heard that signals you have hit his/her aircraft, leaving the motor disabled for about 8 seconds. He/she will still maintain the ability to steer for a safe landing or position himself/herself for a counterattack.



Fly at night with the **Night Flight Module™ (HBZ3510)**. **Recommended for experienced pilots**, this module uses super-bright LED's to illuminate the wing and tail of the selected X-Port equipped aircraft. There are 4 different light modes from which you can choose.

Replacement and Optional Parts (continued)

Optional Parts and Accessories

There are optional parts and accessories that you can buy to make your flying experience more fun. In addition to X-Port™ items, you can also purchase additional battery packs to keep your downtime to a minimum.



Your Firebird Freedom™ comes equipped with an **8.4V 1000mAh Ni-MH Battery Pack (HBZ1013)**. It is helpful to have an extra one or two of these on hand while you're flying so that one can be charging while you're using the other ones.

Future RC Flight

Once you've mastered flying your Firebird Freedom,™ we recommend that you try another 3-channel plane from HobbyZone® for the most successful transition to using larger and faster 3-channel airplanes. The Aerobird Challenger® is a great next step, but you could also try the Aerobird Xtreme.™ Both of these aircraft are X-Port™ equipped, so you'll still be able to have fun with the X-Port accessories you use with your Firebird Freedom. Be warned, however, that the Aerobird Xtreme is much larger and heavier, and will therefore fly much faster than the Aerobird Challenger. If you choose to go from flying the Firebird Freedom to flying the Aerobird Xtreme, we recommend that you have a very experienced RC pilot with you for your first flights until you get comfortable flying a larger, faster airplane. Reacting to difficult situations with the Firebird Freedom is much different than with the Aerobird Challenger and Aerobird Xtreme since they do not have ACT™ and those two airplanes are bigger and faster.

We hope you enjoy flying your new Firebird Freedom, and thank you for supporting HobbyZone. Please let us know how we can help you in the future. We hope your flights with this plane are just the beginning of a long and positive RC experience. Best wishes in the hobby.

Sincerely,
The HobbyZone Team