

HobbyZone® products are distributed exclusively by

Horizon Hobby, Inc.  
4105 Fieldstone Road  
Champaign, IL 61822  
©2003 Horizon Hobby, Inc.

HBZ2515



6 05482 16024 4

**hobbyzone**  
radio control sports  
[hobbyzonesports.com](http://hobbyzonesports.com)

# *FLYERBLIND* **COMMANDER™**



**hobbyzone**  
radio control sports  
Instruction Manual

5611



Congratulations! You have the world's first radio control airplane that can take you from a complete beginner, all the way to Air Combat—the Firebird Commander™ from HobbyZone.

The Firebird Commander is equipped with revolutionary software: Smart-Trak™. When Smart-Trak is in Standard Mode, it automatically recognizes mistakes beginners make (such as over-control,) and compensates for them, while also increasing control during gliding with the motor off to maintain positive control. This software makes the Firebird Commander one of the easiest planes to fly.

Welcome  
to the World of

**hobbyzone**<sup>®</sup>  
radio control sports

Once you're more experienced, you can enter Expert Mode, allowing you to have full control at all times for tighter turns and spirals, as well as other dramatic maneuvers. This extra maneuverability comes in handy when using the X-port. This HobbyZone exclusive port allows the attachment of exciting accessories, including the Sonic Combat Module (SCM) for air-to-air and air-to-ground fighting, and the Aerial Drop Module (ADM), which allows items such as parachutes and streamers to be dropped.

Our mission at HobbyZone is to make sure you have success with the Firebird Commander-to have safe fun and learn a few things along the way.



Crash damage is not covered under the warranty.  
Be sure to read the warranty on page 30 and "Warnings and Safety" on page 27 before you proceed to Step 1.



## Motor Test and Battery Discharging

### Step 3

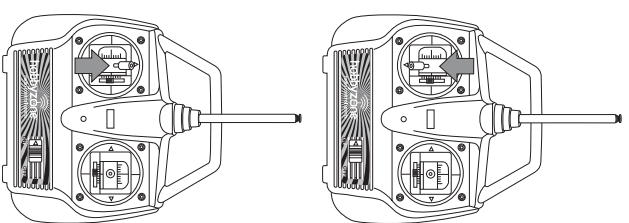

**Adult Supervision Required**  
**WARNING:** Keep everything clear of the propeller and hold the plane securely. A moving propeller can cause severe injury.

1. Turn the transmitter on.
2. Install the battery in the fuselage slot and plug in the connector.
3. Move the transmitter's left stick all the way down and hold for one second. This will arm the motor.
4. Move the transmitter's left stick up. Since most batteries come partially charged, the prop should spin at high speed. (If the motor does not run, proceed to charging the battery.)
5. In order to fully discharge the battery, run the motor at high speed until it shuts off. If there is not enough charge in the battery to power the propeller, then proceed to Step 4.
6. When finished with the motor test, be sure to disconnect the battery first then turn off the transmitter.

## Charging the Aircraft Battery

**Note:** Never charge a hot battery or a battery that is already charged. Always discharge before every charge. See Step 3 for instructions on discharging.

See "Warnings and Safety" on page 27.

1. The charger supplied with the Firebird Commander has a built-in timer. Plug the battery into the charger, and then plug the charger into the wall. The LED indicator should glow constantly. After about 3 hours, the LED will turn off. At this time, the battery is charged and ready to use.
2. To charge another battery, the charger must first be unplugged from both the wall and the battery to reset the timer.

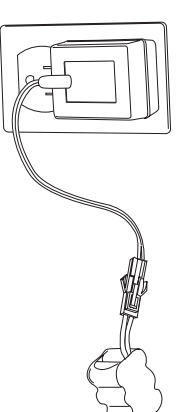

**Important:** Charge the battery shortly before flying. If you charge the battery 12–48 hours before flying, charge again for 30 minutes right before you fly. Stop charging immediately when the battery becomes warm, indicating it is fully charged.

### Step 4

## Step 5

### Tail Control Test

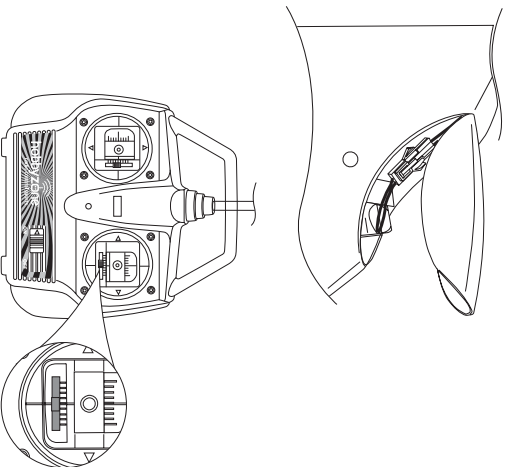

**WATCH OUT!** Be sure to keep everything clear of the propeller before starting the control test. In the event that you accidentally turn on the motor.

1. Switch on the transmitter. Check the LED. Do not touch the sticks for 2 seconds while the transmitter automatically calibrates the controls.
2. Install the battery in the fuselage slot and plug in the connector.
3. Move the right stick side to side. The flaps should move as on the following page. If each flap is not level with the rest of the tail surface when the right stick and trim lever are centered, adjust the control lines so they are level (see page 20).

**Note:** The small levers under or beside the control sticks are called trim levers and are used to adjust the "neutral" point of your control stick. It's very important that these levers are centered when switching on the transmitter and performing the control test.

### Tail Control Test continued

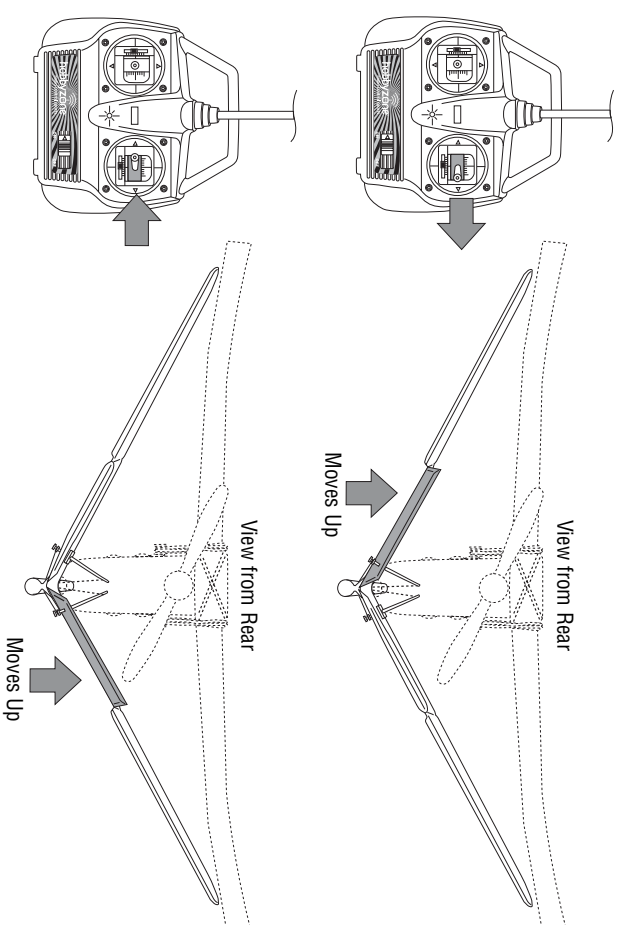

## Step 5

# Step 6

## Choose a Large, Open Grassy Field

- A large, open grass field is required. Your Firebird Commander flies approximately 20 mph, so it covers ground fast. The bigger the field, the better!

- It is absolutely essential to have a minimum of 600 feet of clear space in all directions from the pilot. If you ignore this direction, you will regret it.

**IMPORTANT:** Do not fly over or near people, buildings, power lines, highways, train tracks, vehicles, trees, water, pavement, gravel, any hard surface or any object you don't want to crash into. Please take this warning seriously to keep people, property and your Firebird Commander safe. Crash damage is NOT covered by the warranty.

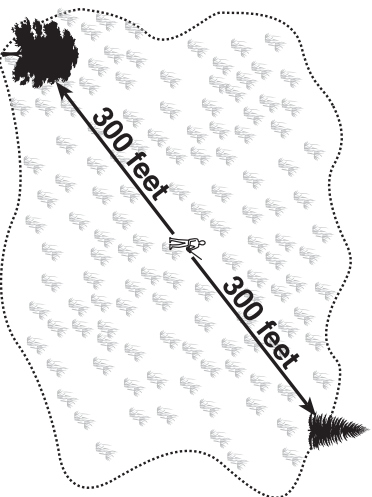
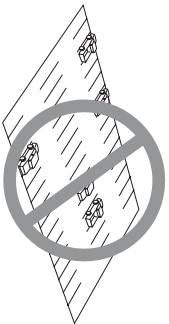

## Choose a Calm Day

You want to fly! If you wait until the day is right, you will have a successful flight. On your first flights, do not fly if the wind is more than 5 mph!

1. Tie the included red flag to the end of your transmitter antenna.
2. Hold the transmitter flat so the antenna is parallel to the ground and note how much the flag moves in the wind. If the flag hangs down, you're good to fly. If the angle between the antenna and the flag is less than 20°, it's too windy for beginning pilots to fly.

**SUCCESS TIP:** Be smart! Follow this tip and protect your Firebird Commander—you'll be glad you did. For beginners, flying in too much wind is by far the #1 reason for crashes and/or lost planes.

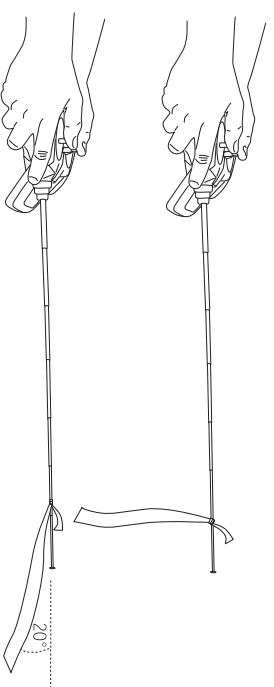
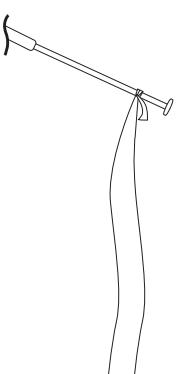

# Step 7

## Step 8

### Range Test

You will need two people to do the range test: one to hold the transmitter and one to hold the airplane.

1. One person holds the transmitter; the other person walks 100 paces away with the airplane.
2. Extend the transmitter antenna completely and turn the transmitter on.
3. Plug in the airplane battery and close the hatch cover.
4. Pull the throttle stick back to arm the motor.
5. As the first person moves both of the transmitter controls at the same time, the other person watches to be sure the airplane's motor and tail controls operate smoothly.
6. If an X-port accessory is attached, test it by pulling down on the left stick to check that it operates correctly.

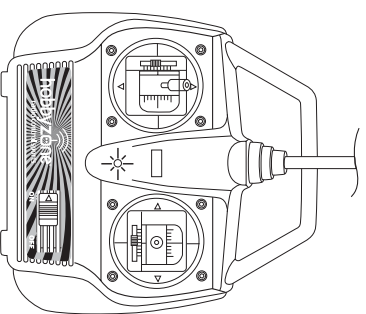

**WATCH OUT!** The person holding the airplane should hold it so that the propeller does not come in contact with any part of their body.

### Range Test continued

If model does not range test correctly, do **not** fly. Call Horizon Hobby Product Support Staff toll-free at 1-877-504-0233 for directions on how to proceed.

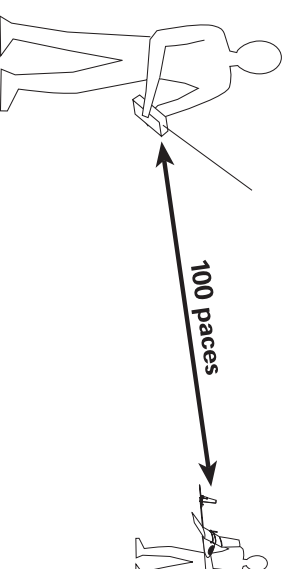

## Step 8

## Step 9

### Hand Launch

#### Hand Launch

1. On first flights, have a second person (adult recommended) launch the Firebird Commander™ while the pilot controls with the transmitter. Adult assistance is always recommended with pilots 12 years of age or younger.
2. Make sure the battery is fully charged.
3. While holding transmitter in one hand, push throttle stick to full on (up) with thumb.
4. Take a couple of steps and launch the model directly into the wind. Keep the wings level. Use medium force. Do not throw it up or down. Point it level with the ground when releasing. Think of it as a javelin that you are throwing 20 feet away.

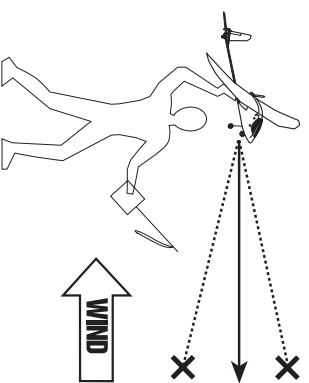

**WATCH OUT!** Keep the spinning propeller away from your hair, head and hands or injury may occur.

**IMPORTANT:** Before launching, determine the wind direction by watching which way the red transmitter ribbon is blowing.

### Runway Takeoff

#### Runway Takeoff

(Not recommended for inexperienced pilots)

1. Stand behind the Firebird Commander™ and point it directly into wind on smooth asphalt or concrete.
2. Apply full power and adjust the right control stick as necessary to keep the Firebird Commander headed directly into the wind.
3. If the battery is fully charged, the Firebird Commander should lift off the ground in approximately 35 feet.

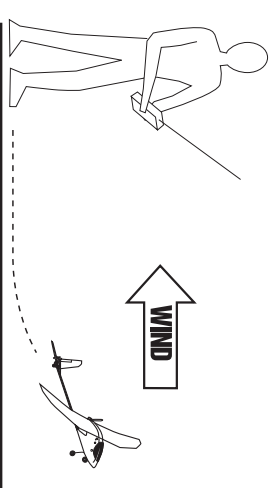

## Step 10

16

### Flying

**Important:** Be careful when holding the right stick full-over right or left for extended amounts of time. In some cases, this can cause the model to spiral dive, and if it does not have sufficient altitude, to crash. If you see the Firebird Commander™ beginning to enter a spiral, release the right stick.

1. After launching, the model will begin climbing. Keep the throttle full on.
2. Make right and left adjustments of the right control stick to keep it flying straight into the wind. Don't attempt a turn until model reaches 50 feet of altitude.
3. Control range is 2500 feet. Don't let the model fly too far away. **Keep upwind**, especially if the wind is over 10 mph, or the wind may carry it away.

### Flying

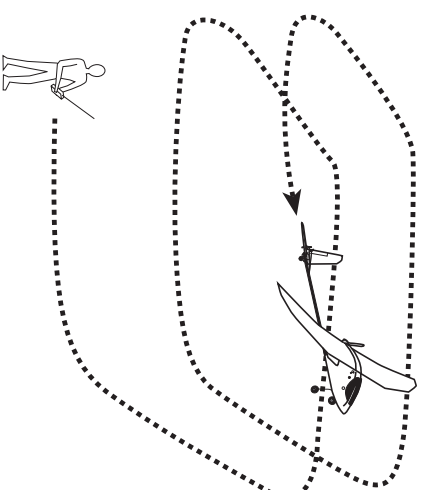

### Turning

Hold the right stick in the direction you want the model to turn.

### Trimming

If the model always turns one direction, use the trim control lever below the control stick to correct (see below). The model should fly straight with the control stick at neutral. See page 20 if additional adjustment is needed.

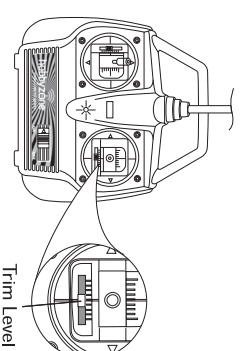

## Step 10

17

## Step 11

### Throttle Adjustment

1. Climb to an altitude of 100 feet or more with full throttle.
2. To achieve a level "cruising" altitude, reduce power by moving the throttle stick down to approximately 50% of full-on.
3. To reduce altitude, reduce throttle.
4. To increase altitude, increase throttle.

**WATCH OUT!** If you're flying with the motor off or at a low speed, allow the Firebird Commander a bit more area for turns.

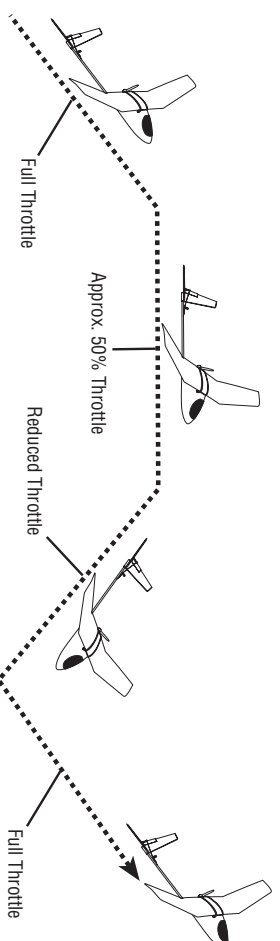

### Landing

When you notice that the Firebird Commander™ no longer climbs well under full power (normally after approximately 12 to 16 minutes), the battery is getting low, and it's time to land. Line the model up, heading directly into the wind toward the desired landing spot. At 10 feet of altitude, gradually reduce the throttle stick to turn off the motor. The Firebird Commander will glide in for a landing.

**Auto Cut-Off Feature:** When your motor battery gets low enough, this feature will automatically shut off the motor and save enough battery to power the radio and tail control so you can land safely. If the motor cuts off, prepare to land immediately.

**WARNING:** Do not attempt to catch the airplane or injury may result. Also, be sure to turn motor off before you touch down or damage can occur to your wing and propeller. Remember to always land directly into the wind.

**Expert tip:** As you get more experienced at flying, try adding a small "blip" of power just before touchdown. With some practice, you'll be able to land it right on target.

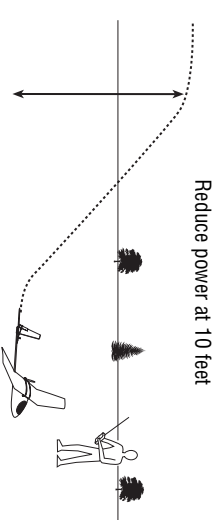

## Step 13

20

### Making adjustments – Leveling the Tail Control Flaps

Before making your first flight, if tail control flaps are not level with rest of tail surface, adjust them so they are level by doing the following:

1. Turn the transmitter on, plug in aircraft battery and center the right control stick and trim lever.
2. Use your fingers or a small flat screwdriver to turn the slotted spool on the control horn. Depending on the direction you turn, this will lengthen or shorten the control line.
3. While applying some tension to the control lines, adjust until the control surfaces are level with the rest of the surface.

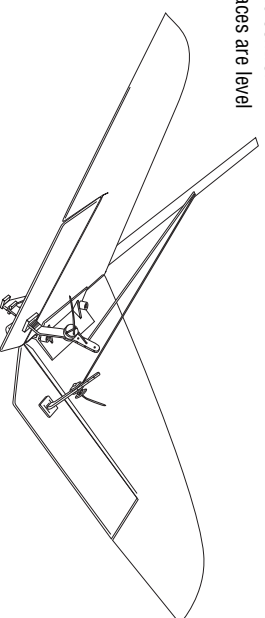

### Making Adjustments – Plane Turns to the Left or Right

**IMPORTANT:** If there is a bend (even a small one) in the tail or wing or a tear near the flap areas, it is impossible to have correct flight control. Replace the damaged part immediately!

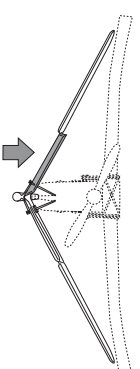

- A.** If the Firebird Commander keeps turning to the left and adjusting the trim control lever (page 17) does not correct enough to fly straight with the stick at neutral:
1. Adjust the control line so that the left tail flap is 1/16" above the rest of the tail surface.
  2. Test fly.
  3. If it still flies to the left, repeat the above procedure, adding 1/16" each time until it flies straight.

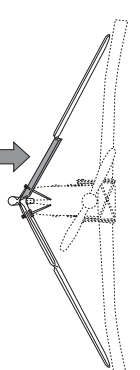

- B.** If the Firebird Commander keeps turning to the right and adjusting the trim control lever (page 17) does not correct enough to fly straight with the stick at neutral:
1. Adjust the control line so that the right tail flap is 1/16" above the rest of the tail surface.
  2. Test fly.
  3. If it still flies to the right, repeat the above procedure, adding 1/16" each time until it flies straight.

## Step 13

21

## Step 14

22

### Making Adjustments to the Climb Rate

- A.** If the Firebird Commander™ (with a fully charged battery) does not climb fast enough with full throttle, you can adjust the climb rate by:
1. Tightening the front tail screw in one full turn and loosening the rear tail screw one full turn.
  2. Test fly.
  3. Repeat the above procedure if necessary until the Firebird Commander climbs adequately under full power.

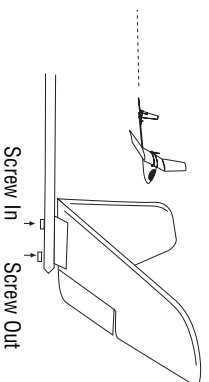

- B.** If the Firebird Commander climbs too fast with full throttle by climbing at a steep angle, stalling and keeps repeating climbing sharply and stalling, do the following:
1. Loosen the front tail screw one full turn and tighten the rear screw one full turn.
  2. Test fly.
  3. Repeat the above procedure if necessary until your Firebird Commander climbs at a steady rate.
  4. If after making maximum adjustments your Firebird Commander still climbs too steeply, add the wing shim (see page 23.)

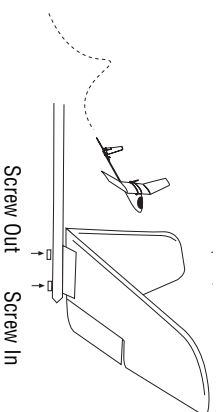

### Adding the Wing Shim—To Adjust Climb Rate and Speed

**Needed for Step 15**  
1 mm wing shim (included)

- If the climb rate is still too steep after making the tail screw adjustments on page 22, add the included wing shim.
1. Place the wing shim on top of the fuselage at the rear of the wing saddle as shown.
  2. Place the wing over the wing shim and rubber band the wing to the fuselage as normal.

This will cause the Firebird Commander to climb less steeply and reduce the tendency to repeatedly climb and stall. Add the wing shim when the wind is gusting more than 10 mph.

**IMPORTANT:** Adding the wing shim will cause the Firebird Commander to fly faster, due to the wing's reduced incidence angle.

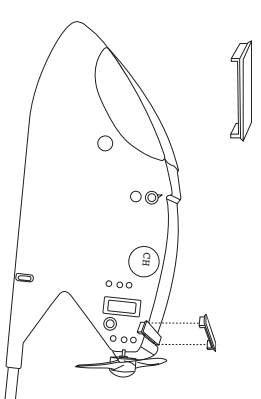

23

## Step 15

## Step 16

### Entering Expert Mode

Once you have mastered the Smart-Trak™ Standard Mode of the Firebird Commander™, you can activate the Expert Mode to disable the software portion of Smart-Trak. In this mode, you will have full control at all times. The Firebird Commander will turn tighter and easily enter a spiral. This is great for combat and experienced pilots, but not for beginners!

**Note:** The expert mode is recommended but not required when using X-port accessories. The Smart-Trak Standard Mode is calibrated for use with the standard 6-cell battery. The optional 7-cell battery is only recommended for experts using the Expert Mode.

1. Start with the **transmitter off** and the battery out of the plane.
2. Always hold the plane securely with all body parts away from the propeller when the flight battery is installed or being installed.
3. Install and plug in the flight battery.
4. While holding the throttle stick full forward, switch on the transmitter continue holding full throttle for 3 seconds, then release the throttle stick. You are now in Expert Mode!
5. Before launching, pull the throttle stick back all the way to arm the motor. Test the motor with a blip of power before launching.
6. Repeat this procedure if expert mode is desired every time you install a flight battery.

### Entering Expert Mode continued

#### Testing the Mode (Optional)

You may check to see what mode you are in after power up, but **before** pulling the throttle back to arm the motor:

1. Push and hold the throttle stick **forward**. (The motor should not run since it is not armed.)
2. While holding the throttle stick forward, push the right stick all the way to the **right** and hold it there.
  - If the left control surface deflects up, holds for about half a second, then reduces to about half way up, you are in Smart-Trak **Standard** Mode.
  - If the left control surface deflects up and stays up the same amount continuously, you are in **Expert** Mode.

## If a Crash Occurs

1. If you happen to crash and part of the foam wing or tail breaks, it can be repaired using packing tape to cover missing pieces.
2. If damage is severe or if wing or tail is bent, replace damaged parts immediately. See pages 31–32 for a complete replacement parts list.

### **IMPORTANT:** Control Alignment

*Tail flaps must be level or nearly level with no slack in the control lines or the plane will not fly well. See pages 20 and 21 if adjustment is necessary.*

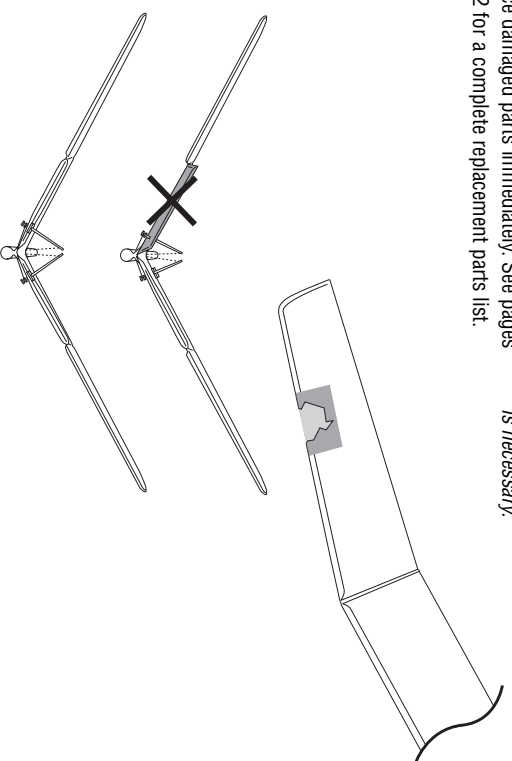

26

## Warnings and Safety

1. Read and follow this manual and included video completely, observing all instructions and safety directions. Otherwise, serious injury and damage can occur. Think safety first.
2. Keep propeller away from body parts, even when it isn't spinning as it could be turned on by accident. Beware of hair becoming entangled in the propeller, especially while launching the Firebird Commander™ on a windy day or injury may occur.
3. Do not fly when it's too windy (as described in STEP 7) or you may lose control and crash, causing injury or damage. Never fly the Firebird Commander near people, vehicles, train tracks, buildings, power lines, water, hard surfaces or trees. Never allow anyone to attempt to catch the Firebird Commander while it's in flight or serious injury can result.
4. Adult supervision is recommended for ages 12 and under.
5. Battery Charging: Only use a battery charger intended for use with the Firebird Commander battery. Never leave charger unattended while charging. This will help prevent overcharging. While charging, place the battery on a heat-resistant surface. Do not lay it on carpet or upholstery while charging. Never charge the battery with the included charger for more than 3 hours.
6. Never cut into the battery charger or airplane wires or serious injury can occur. Causing the battery to "short out" (crossing negative and positive bare wires) can cause fire, serious injury and damage.
7. Hold the plane securely, and keep all body parts away from the propeller when the flight battery is plugged in. When you finish flying the Firebird Commander, always unplug the battery before you turn off the transmitter.
8. Never fly on the same frequency as another RC vehicle in your area. The frequency of the Commander is shown on stickers on the back of the transmitter.

27

## Troubleshooting

PROBLEM	POSSIBLE CAUSE	SOLUTION
Unit does not operate	<ol style="list-style-type: none"> <li>1. Transmitter "AA" batteries are depleted or installed incorrectly by a dim or unit LED on transmitter or the low battery alarm</li> <li>2. No electrical connection</li> <li>3. Firebird Commander battery not charged</li> <li>4. Crash has damaged the radio inside the Firebird Commander</li> </ol>	<ol style="list-style-type: none"> <li>1. Check polarity installation or replace with fresh "AA" batteries</li> <li>2. Push connectors together until they "click"</li> <li>3. Charge battery fully</li> <li>4. Replace the fuselage</li> </ol>
Aircraft keeps turning in one direction	<ol style="list-style-type: none"> <li>1. Tail flaps need adjustment</li> <li>2. Wing is not centered over the fuselage</li> </ol>	<ol style="list-style-type: none"> <li>1. Adjust stick trim lever (see page 17) or adjust tail flap position (see page 20-21)</li> <li>2. Center the wing before each flight</li> </ol>
Aircraft is difficult to control	<ol style="list-style-type: none"> <li>1. Tail flaps aren't adjusted properly</li> <li>2. Wing or tail is damaged</li> </ol>	<ol style="list-style-type: none"> <li>1. Adjust tail flaps (see pages 20-21)</li> <li>2. Repair or replace</li> </ol>
Aircraft keeps pitching up steeply	<ol style="list-style-type: none"> <li>1. Tail incidence needs adjustment</li> <li>2. Wing incidence needs adjustment</li> <li>3. Wind is too gusty or strong</li> </ol>	<ol style="list-style-type: none"> <li>1. Adjust tail screws (see page 22)</li> <li>2. Add wing shim (see page 23)</li> <li>3. Postpone flying until wind is more calm</li> </ol>
Aircraft won't climb	<ol style="list-style-type: none"> <li>1. Battery isn't fully charged</li> <li>2. Tail needs adjustment</li> </ol>	<ol style="list-style-type: none"> <li>1. Charge battery shortly before flying</li> <li>2. Adjust tail screws (see page 22)</li> </ol>

## Success Tips

1. A "must" for beginners: Don't fly in winds over 7 mph!
2. Important: Choose a flying field carefully—grass and soft ground with 600-foot diameter is optimal to fly and will lengthen the life of the Firebird Commander™.
3. Watch out! Holding the right stick full-over for too long may cause the Firebird Commander to spiral dive and crash. At the very first sign of the Firebird Commander beginning to spiral down, immediately release the stick and give the opposite control to level the wings.
4. Purchase an extra battery pack for added fun at the flying field.
5. If you're gliding with the motor off, allow the Firebird Commander a little more area for turns.
6. Position yourself at your flying field to keep the sun at your back and out of your eyes. Wear sunglasses on bright days.
7. Keep the Firebird Commander upwind, especially on windy days, to prevent it from "flying away." The wind is normally stronger at higher altitudes than it is on the ground.
8. Keep your plane in front of you so you don't have to turn in circles as you fly. Try to avoid flying directly overhead.
9. Don't attempt to fly or do combat maneuvers beyond your flying abilities.

To learn more about flying RC model airplanes, location of the nearest AMA club, AMA safety code, frequency guidelines and much more we highly recommend that you contact:

Academy of Model Aeronautics  
5161 East Memorial Drive  
Muncie, Indiana 47302  
Toll-Free (800) 435-9262  
www.modelaircraft.org

## Warranty and Follow-Up Procedures

Due to the nature and operation of this product, the warranty does not extend beyond the initial preflight testing. Carefully check the parts and operation BEFORE your first flight. Damage incurred during flying combat, landing, crashing or modification is not covered under the warranty.

**Warranty:** Horizon Hobby, Inc. guarantees this product to be free of defects in material and workmanship. If you discover defects during the very first preflight testing (Steps 1–8, & 13), please call our Product Support staff toll-free at 1-877-504-0233 for technical support. If you are directed by them to return the product to our Service Center, you will be provided with a RA (Return Authorization) number. If, in our opinion, after inspecting the product, we determine it to be defective, we will repair or replace it at our discretion.

If you are directed by our Product Support staff to return the Firebird Commander™, please follow these instructions.

1. Unplug the battery from the airplane.
2. Pack the complete Firebird Commander (all components in the original box) and put into a sturdy shipping carton for protection.
3. Include your complete name and address information inside the carton, as well as clearly writing it on the outer label/return address area. Include detailed information explaining the nature of the problem(s) encountered.
4. Please date your correspondence and be sure your complete name, address and daytime phone number appear on this enclosure. Please include your original dated sales receipt. Mail to the address below.

Horizon Service Center  
Attn: HobbyZone Dept.  
4105 Fieldstone Rd.  
Champaign, IL 61822

## Replacement Parts

Keep that Firebird Commander flying! Spare parts are available from your dealer or from Horizon Hobby direct ([www.horizonhobby.com](http://www.horizonhobby.com)). Please check with your dealer first—by supporting your dealer, they'll be there when you need them. To locate your local dealer, go to [www.hobbyzone.com](http://www.hobbyzone.com)





Item #	Description	Retail	Item #	Description	Retail
HBZ1012	7.2v 900 mAh NiMH Battery	\$24.99	HBZ4060	1mm Wing Shim	\$0.99
HBZ2510	Standard Decal Sheet: FB Commander	\$4.99	HBZ2012	White Tail V-Brace: FB Commander, XL	\$1.49
HBZ2515	Instruction Manual: FB Commander	\$0.99	HBZ2013	White Tail Screws (2): FB Commander, XL	\$0.99
HBZ2516	Commander Instructional VideoCD	\$2.99	HBZ6035	Tail Horn and Keeper (2)	\$0.89
HBZ2517	Canopy cover w/Hardware: FB Commander	\$2.49	HBZ2561	FB Commander Fuselage: CH 1	\$49.99
HBZ2519	3 Hour Wall Charger for 7.2v 900mAh	\$9.99	HBZ2562	FB Commander Fuselage: CH 2	\$49.99
HBZ2521	White Standard Wing: FB Commander	\$14.99	HBZ2563	FB Commander Fuselage: CH 3	\$49.99
HBZ2531	White Tail w/accessories: FB Commander	\$9.99	HBZ2564	FB Commander Fuselage: CH 4	\$49.99
HBZ2004	Propeller: Commander, XL, FTB, AB	\$2.99	HBZ2565	FB Commander Fuselage: CH 5	\$49.99
HBZ2010	2 Wing Hold-Down Rods w/Caps: FB Commander, XL	\$1.49	HBZ2566	FB Commander Fuselage: CH 6	\$49.99
HBZ2016	Main Landing Gear with Wheels	\$3.99	HBZ3351	Transmitter: CH 1, ZZR, FBC	\$24.99
HBZ1058	Transmitter Antenna	\$4.99	HBZ3352	Transmitter: CH 2, ZZR, FBC	\$24.99
HBZ1059	Ribbon for Transmitter Antenna	\$0.79	HBZ3353	Transmitter: CH 3, ZZR, FBC	\$24.99
HBZ1060	Transmitter Battery Cover	\$2.49	HBZ3354	Transmitter: CH 4, ZZR, FBC	\$24.99
HBZ2011	White Rubber Bands (5): FB Commander, XL	\$0.99	HBZ3355	Transmitter: CH 5, ZZR, FBC	\$24.99
HBZ2008	White Wing Cap (4): FB Commander	\$1.29	HBZ3356	Transmitter: CH 6, ZZR, FBC	\$24.99

## Commander Options

Item #	Description	Retail	Item #	Description	Retail
HBZ1026	12V DC Peak Charger	\$19.99	HBZ1509	Yellow Wing Cap (4): FB Commander	\$1.29
HBZ1013	8.4V 900mAh Ni-MH Battery (Requires HBZ1026 Charger)	\$29.99	HBZ4070	Silver Wing Cap (4): FB Commander	\$1.29
HBZ6023	Aerial Drop Module	\$19.99	HBZ4071	Red Wing Cap (4): FB Commander	\$1.29
HBZ4020	Sonic Combat Module	\$23.99	HBZ1055	Yellow Tail V-Brace: FB Commander	\$1.49
HBZ4025	Stealth Target (works with Sonic Combat Module)	\$23.99	HBZ4051	Silver Tail V-Brace: FB Commander	\$1.49
HBZ2520	Silver Wing - FB Commander	\$14.99	HBZ4050	Red Tail V-Brace: FB Commander	\$1.49
HBZ2522	Yellow Wing - FB Commander	\$14.99	HBZ1056	Yellow Tail Screws (2): FB Commander	\$0.99
HBZ2523	Red Wing - FB Commander	\$14.99	HBZ4054	Silver Tail Screws (2): FB Commander	\$0.99
HBZ2530	Silver Tail w/accessories: FB Commander	\$9.99	HBZ4055	Red Tail Screws (2): FB Commander	\$0.99
HBZ2532	Yellow Tail w/accessories: FB Commander	\$9.99	HBZ2511	Space Explorer Decal Sheet	\$4.99
HBZ2533	Red Tail w/accessories: FB Commander	\$9.99	HBZ2512	Nebula Squadron Decal Sheet	\$4.99
			HBZ2513	USAF Decal Sheet	\$4.99

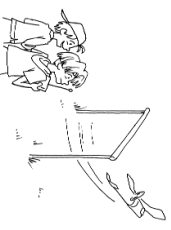
## More Fun with the Firebird Commander™

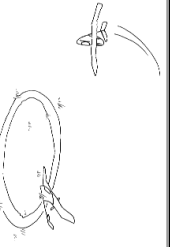
After a little practice with your Firebird Commander you'll be ready to take on the added challenge of the games shown below. Test your own skills or challenge your family and friends to some competition.

<p><b>1. Limbo</b></p> 	<p><b>2. Pylon</b></p> 
<p><b>3. Spot Landing</b></p> 	<p><b>4. Duration</b></p> 

## HobbyZone® Accessories



### HBZ1026 DC Peak Charger

Charge your battery from your car in about 40 minutes with our DC Peak Charger, including adapter to charge most HobbyZone Aircraft and ZigZag Boat batteries.



### HBZ4020 Sonic Combat Module (SCM)

Plug in the Sonic Combat Module and take on similarly equipped HobbyZone planes in aerial combat. When "hit", the SCM temporarily disables your motor while allowing you to steer.

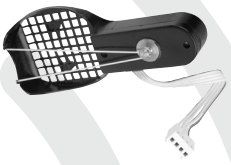

### HBZ6023 Aerial Drop Module (ADM)

Plug in the Aerial Drop Module and you can drop a streamer bomb or parachute, both of which are included.



### HBZ4025 Stealth Target

An optional Stealth fighter ground target with "hit" sensor is available so you can practice with the Sonic Combat Module or take on friends in a target shooting contest.

## Firebird Commander Combat Options

### Fun Games with the Target

1. See how many hits you can get in a measured time, such as 3 minutes.
2. See how many hits you can get in one battery pack.
3. Attack the target with two or more Firebird's at the same time. See who can time their attack runs properly and get the most hits in 5 minutes.

Be sure to turn off the power switch on the bottom when you are done. If the target fails to register hits, you may need to replace the 9V battery.



### Let the Dogfighting Begin

Have from 2-6 Firebird Commanders (or other X-port equipped Hobbyzone aircraft,) flying on different frequencies and engage in air combat with the **Sonic Combat Module (SCM)**.

