

NITRO HAMMER™



AQUACRAFT™
Models by **HOBBICO®**

Warranty

- AquaCraft™ will warrant this kit for 90 days after the purchase from defects in materials or workmanship. AquaCraft will either repair or replace, at no charge, the incorrectly made part.
- Make sure you save the receipt or invoice you were given when you bought your model! It is your proof of purchase and we must see it before we can honor the warranty.
- To return your Nitro Hammer™ for repairs covered under warranty you should send your boat to:

Hobby Services
1610 Interstate Drive
Champaign, Illinois 61822
Attn: Service Department
Phone: (217) 398-0007 9:00 am - 5:00 pm Central Time M-F
E-mail: hobbyservices@hobbico.com

Before Building:

We want the assembly and operation of this boat to be a success so **BEFORE** removing any parts from the parts bags please read this manual thoroughly and watch the included video to familiarize yourself with the model. If for any reason you think this model is not for you, return it to your local dealer immediately. **PLEASE NOTE:** Your hobby dealer cannot accept a return on any model after assembly has begun.

TABLE OF CONTENTS

INTRODUCTION	2
SAFETY PRECAUTIONS.....	2
HELPFUL HINTS	2
REPAIR SERVICE	2
SPECIFICATION & DESCRIPTION CHANGES	2
SCREW INFORMATION	3
BOAT TERMINOLOGY	3
FIELD EQUIPMENT	3
TOOLS YOU WILL NEED	3
FINISHING THE NITRO HAMMER	3
FINAL ASSEMBLY	3
RUNNING THE ENGINE.....	4
BREAKING IN THE ENGINE	5
ENGINE MAINTENANCE	5
PERFORMANCE TRICKS AND TWEAKS	7
RACING	7
ORDERING REPLACEMENT PARTS.....	BACK COVER
TROUBLESHOOTING FLOWCHART	BACK COVER

INTRODUCTION

Thank you for purchasing the AquaCraft Nitro Hammer! This manual contains the instructions you need to safely build, operate and maintain your nitro R/C boat. Read over this manual thoroughly before operating the Nitro Hammer.

SAFETY PRECAUTIONS

- Use care to avoid touching the propeller anytime the engine is running. Pay equally close attention to items such as loose clothing, shirtsleeves, ties, scarves, long hair or anything that may become entangled in the spinning prop. If your fingers, hands, etc. come in contact with the spinning propeller, you may be severely injured.
- Because of the speed and mass of this boat, it is capable of inflicting property damage and severe personal injury if a collision occurs. Never run this boat in the presence of swimmers or where the possibility of collision with people or property exists.
- This boat is controlled by radio signals, which are subject to possible interference from other R/C transmitters, paging systems or other electrical noise. Before turning your radio on, make sure no one else in the area is operating a radio on the same frequency (channel).
- Model engine fuel is poisonous. Do not allow it to come into contact with the eyes or mouth. **Always store fuel in a clearly marked container and out of the reach of children.**
- Model engine fuel is highly flammable. Keep it away from open flame, excessive heat, sources of sparks, or anything else that might ignite it. **Do not smoke or allow anyone else to smoke** in close proximity to open fuel. Make sure that fuel lines are in good condition so that fuel will not leak onto a hot engine causing a fire.

- Never operate your engine in an enclosed space. Model engines, like automobile engines, exhaust deadly carbon monoxide. **Run your engine only in an open area.**
- Model engines generate considerable heat. Do not touch any part of your engine until it has cooled. Touching the muffler, cylinder head, or exhaust header may result in a serious burn.
- Use safety glasses when starting or running engines. The propeller may throw loose material such as sand or gravel into your face.

Avoid running the boat in cold weather. The hull and plastic parts can become brittle at low temperatures. In addition, grease and oil become thick, causing premature wear and poor performance.

If the buyer is not prepared to accept the liability associated with the use of this product, the buyer is advised to return this kit immediately in new and unused condition to the place of purchase.

HELPFUL HINTS

- Avoid working over a deep pile carpet. If you drop a small part or screw, it will be difficult to find.
- Place a mat or towel over your work surface. This will prevent parts from rolling off and will protect the work surface.
- Test fit all parts before attaching them permanently.

REPAIR SERVICE

Repair service is available anytime.

After the 90-day warranty, you can still have your Nitro Hammer repaired for a small charge by the experts at AquaCraft's authorized repair facility, **Hobby Services**, at the address listed on the front page of this manual. To speed up the repair process, please follow the instructions below.

1. Under all circumstances return the **ENTIRE** system, boat and radio.
2. Make sure the transmitter is turned off, **all batteries are removed and fuel is drained** from the tank.
3. Send written instructions which include: a list of all items returned, a **THOROUGH** explanation of the problem, the service needed and your phone number during the day. If you expect the repair to be covered under warranty, be sure to include a proof-of-purchase date (your store receipt or purchase invoice).
4. Also be sure to send your full return address.

SPECIFICATION & DESCRIPTION CHANGES

All pictures, descriptions and specifications found in this instruction manual are subject to change without notice. AquaCraft maintains no responsibility for inadvertent errors in this manual.

SCREW INFORMATION

Do not use too much force when tightening self-tapping screws into plastic or fiberglass. Over tightening will cause the threads in the plastic to strip. We recommend that you stop turning a self-tapping screw once you feel some resistance as the head of the screw comes in contact with the plastic. Avoid using powered screwdrivers when assembling this kit. They tend to over tighten the screws. Do not use thread-locking compound on self-tapping screws. The thread-locking compound may damage the plastic. **IMPORTANT:** Use thread lock on any fastener that is threaded into metal or fastened with a nut. Vibration from the engine will cause the screws to loosen if thread-locking compound is not used.

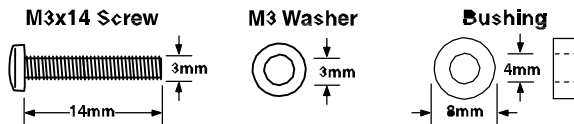

BOAT TERMINOLOGY

- **BOW:** The front of the boat
- **STERN:** The back of the boat
- **PORT:** This is the left side of the boat when aboard and facing the front (bow).
- **STARBOARD:** This is the right side of the boat when aboard and facing the front (bow).
- **HULL:** The body of the boat.
- **DECK:** The top of the boat.

REQUIRED FIELD EQUIPMENT



- HCAP2520 Hot Shot™ 2 Glow starter
- 10-20% Nitromethane Model Car Fuel
(10%–DTXP0570, 20%–DTXP0600)

Other Useful Items to Have On Hand:

- OSMG2691 Glow Plugs
- GPMQ4131 Fuel Tubing
- HCAP3000 After Run™ Engine

TOOLS YOU WILL NEED

- Phillips head screwdriver (HCAR1022)
- 4-way wrench (DTXR1170)
- Needle-nose pliers (HCAR0625)
- Adjustable wrench or 5.5mm wrench (for changing propellers)

FINISHING THE RTR NITRO HAMMER

Decals have been provided for your Nitro Hammer. Simply cut them out, peel and stick! See the photos on the box for decal placement.

FINAL ASSEMBLY

Carefully remove your Nitro Hammer from the box and place it atop the pre-built boat stand. Remove all remaining components from the box. **You may wish to keep the box in order to more easily transport and store your Nitro Hammer.**

Transmitter Assembly

○ 1. Remove the transmitter antenna from the parts bag and screw it into the top of the transmitter. To ensure that the antenna is attached, lightly pull on the base of the antenna. If it slides out, it is not installed properly.

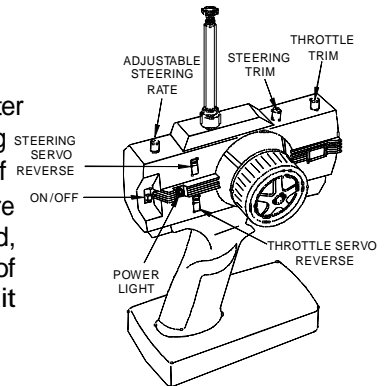

○ 2. Slide off the battery door on the bottom of the transmitter. Install 8 new “AA” batteries into the bottom of the transmitter in the configuration molded into the battery holder. Re-install the battery door onto the bottom

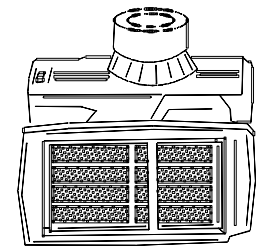

Install (8) new “AA” batteries

○ 3. Turn the transmitter on using the switch on the front. The red LED light next to the on/off switch should light up. If the LED does not light up, turn the transmitter off and check to make sure that the batteries are installed properly. **If you see a flashing LED, the batteries are low and need to be replaced.**

Receiver Preparation

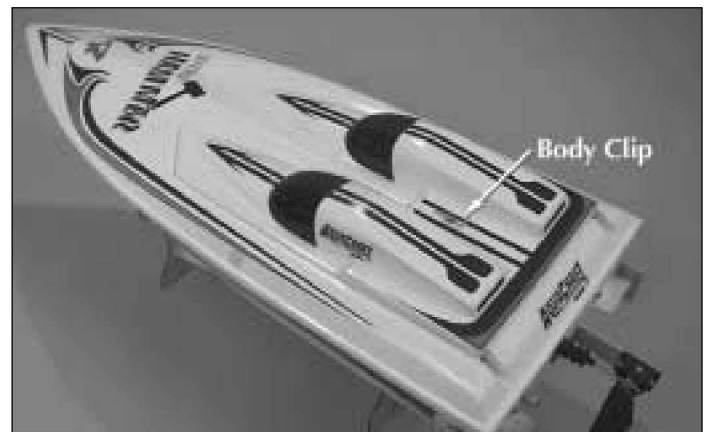

○ 1. Remove the body clip at the rear of the top deck and carefully remove the hatch.

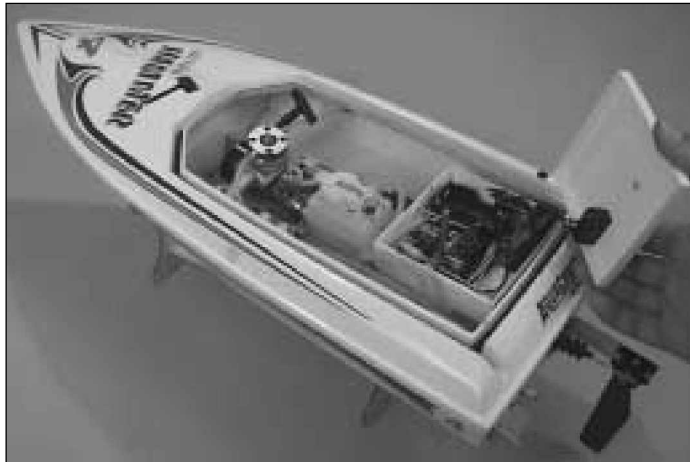
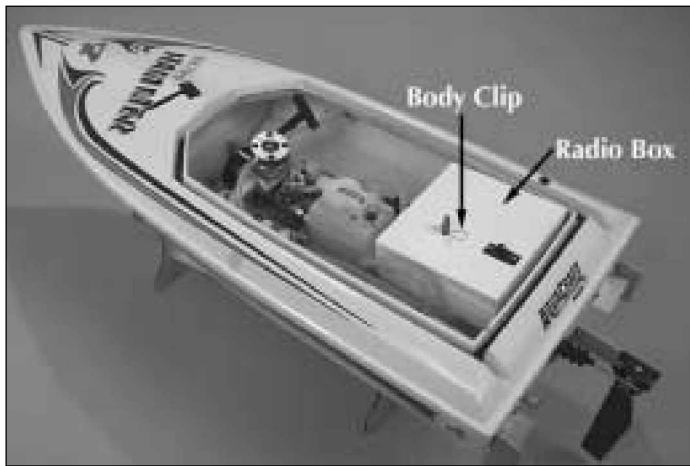

- 2. Remove the body clip that holds the lid to the radio box and carefully remove the cover.

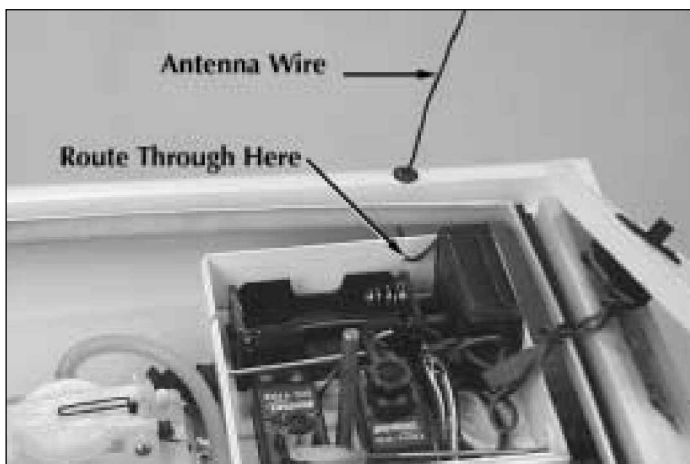

- 3. Carefully uncoil the receiver antenna and route it through the small hole on the side of the radio box and up through the antenna hole.

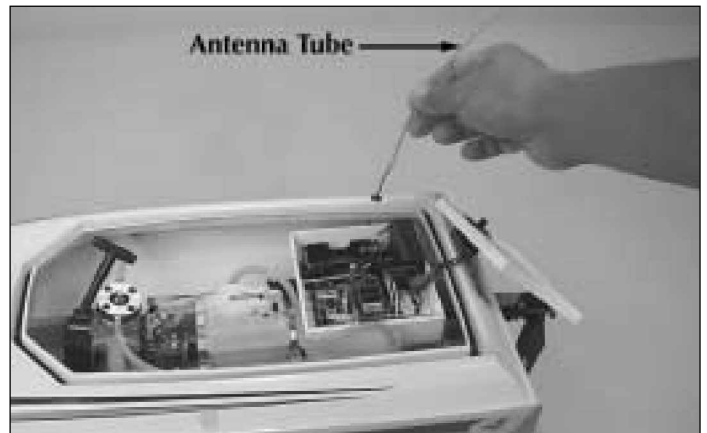

- 4. Slide the antenna wire through the antenna tube and place the antenna tube into the rubber grommet. **DO NOT CUT OFF THE EXCESS ANTENNA WIRE!**

Installation of Batteries

- 1. Place four (4) new "AA" batteries into the receiver battery holder. Be sure to follow the configuration molded into the battery holder.
- 2. Put the radio box cover back on and replace the body

Check the Radio System:

- 1. Standing behind the boat with both the vessel and transmitter powered up, rotate the wheel to the left. The back of the rudder should move towards the left. Move the wheel to the right. The back of the rudder should move towards the right. If this is not the case, simply move the steering servo reverse switch to the other position.
- 2. Squeeze the trigger on the transmitter; this should open the throat of the carburetor. Conversely, moving the trigger forward will close the throat completely.
- 3. The adjustable steering rate knob (labeled D/R) located atop the transmitter (see page 3) is the steering rate adjustment. Turning the knob to the right increases the amount of travel of the rudder while turning it to the left decreases the rudder amount of travel. Beginners may want less amount of travel to

RUNNING THE ENGINE

Before running the engine, read the manual and watch the video that came with this kit.

There are Several Simple Steps to Starting the Engine:

- 1. Install a glow plug if one is not in your engine. The glow plug threads into the top of the cylinder head.
- 2. Fill the tank almost to the top. Leave a little air at the top of the tank.

○ 3. Open the high-speed needle valve 2-1/2 turns out (counterclockwise) from fully closed. The high-speed needle is sticking up on the left side of the carburetor (looking at it from behind the boat). If you have previously run the boat, keep the same needle valve setting that you used on your last run.

○ 4. Prime the engine by pushing the primer button on the fuel tank 2-3 times or until you see fuel entering the carburetor. The quantity of fuel drawn into the engine by priming is an important factor in starting the engine successfully.

IMPORTANT: The propeller will begin spinning as soon as the engine starts! Be certain that the propeller is unobstructed; failure to do so will damage the prop.

Carburetor Partially Open

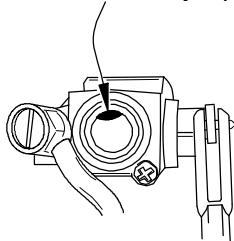

○ 6. Check that the throttle is 1/8 open from the fully closed position. Pull the handle of the recoil starter in quick, short pulls. Repeat, if necessary until the engine fires. **DO NOT PULL THE RECOIL HANDLE OUT ANY MORE THAN 15 INCHES; DOING SO MAY DAMAGE THE PULLSTART.**

○ 7. With the engine started, remove the glow starter after 10-15 seconds.

If the engine fails to start, refer to the TROUBLE SHOOTING CHART on the back cover.

Fuels

Use nitro fuels that are specially formulated for model engines. Typically this would be 10-20% Nitro-methane car fuel.

BREAKING IN THE ENGINE

In order to perform adjustments as needed, the break-in procedure should be performed on dry land with your Nitro Hammer securely held in place.

To insure long life and good performance from your AquaCraft Pro .15 engine, you **MUST** break-in the engine. The break-in period is critical for long life of the internal parts of the engine. This should be done over the first 5 or 6 tanks of fuel. Be sure to watch the engine tuning video that came with this kit.

Some Things to Remember During Break-In

1. Use the same fuel that you will use for normal running.
2. Resist the urge to accelerate and decelerate the boat quickly.
3. Break-in puts stress on the glow plug and you can burn it out during break-in. Make sure you have an extra plug or two on hand.

How To Stop Your Engine

Just as squeezing the throttle trigger on your transmitter increases power, pushing the trigger the opposite way decreases power. Pushing the throttle trigger forward will close off the throat of the carburetor completely, cutting off air intake and stopping the engine.

The First Tank

Your first tank of fuel should be running the boat at a very rich high-speed needle valve setting. This allows the fuel to carry as much oil as possible into the engine to lubricate the internal parts during the break-in.

1. Open the needle valve 2-1/2 turns out from fully closed (counterclockwise). This is factory set already, but check it to make sure. When closing the high-speed needle, close the needle until you feel some resistance. **DO NOT** overtighten or you will damage the carburetor.
2. Start the engine.
3. Once the engine is started, open the high-speed needle valve around 1/8 turn at a time, finding the setting where the engine just barely runs. This may take a few times adjusting the needle. The engine will perform sluggishly and stall from time to time - this is normal during the break-in process.
4. Place the boat in water and run the engine at a medium speed, periodically accelerating and decelerating.
5. Continue running the engine until the tank is almost out of fuel. Do not allow the engine to run out of fuel. This leans out the engine and can cause overheating.

Tanks 2-6

Turn in the needle valve (clockwise) around 1/8 turn from the previous setting. You should notice that the engine performs better during each run. After the 6th tank, you should be near to the peak performance of the engine.

ENGINE MAINTENANCE

Ways To Ensure A Long Life For Your Engine.

1. Keep your engine clean. Dirt will act as insulation on an engine. It will not be able to shed heat as easily.

2. Do not over-lean your engine.
3. Do not run your engine without a propeller.
4. Do not over heat the engine. This goes along with keeping it clean and not over-leaning the engine.
5. Make sure that you use a fuel from a reputable manufacturer that is labeled as model engine fuel.
6. Avoid using old fuels in the engine. Always run all of the fuel out of the engine. After running for the day, use after-run oil and work it into the engine by pulling the pull-starter 2-3 times.
7. Do not use a fuel with a Nitromethane (often called nitro) content over 30%.
8. Do not use silicone sealer on the engine joints. Silicone sealer contains acetic acid, which is corrosive if it gets inside your engine.
9. Store your engine someplace where it will not be subjected to extreme temperature changes.

If you are having problems with your engine consult the engine-troubleshooting flowchart on the back cover of this manual. The following are some potential problems.

Glow Plug

The glow plug is an item that will wear out and need replacement from time to time. It is a good idea to remove the glow plug before your first run, heat it and see how well it glows. You should see a bright orange glow from the filament. If a coil or two will not glow or the plug will not glow at all, replace the plug. If the engine quits when you remove the glow starter, the plug might need to be changed, although this may be because you are running too rich and need to screw in your high-speed needle some. Look at the glow plug when you are running the engine. If you see some bubbles coming from around the plug, replace the glow plug (copper) gasket, or both the plug and the gasket. The only real way to test a glow plug is to replace it. Make sure you have a spare plug or two on hand every time that you run the Nitro Hammer.

Fuel Fuel can go bad. The main ingredient in model fuel is methanol, which is basically a form of alcohol. Alcohols can absorb water out of the air, so keep your fuel jug capped at all times. Store your fuel out of the sunlight and in a cool place. Bad fuel is one of the most difficult problems to diagnose in engines. If you have tried everything you can think of to remedy an engine that is not running correctly, try using some fresh fuel.

Fuel line is susceptible to pinhole leaks. You cannot see the hole in the fuel line, but if you see bubbles in the line going to the carburetor, replace the fuel line. Another symptom of a leak in the fuel line is a surging engine. The properly tuned engine will surge when the air bubbles enter the carburetor. It is basically leaning out the mixture.

Overheating

One of the worst things you can do to your engine is overheat it. The oils that lubricate the engine are carried in the fuel. If your engine is set too lean, there will not be enough oil in the engine to lubricate the internal parts. This will cause premature wear in the engine and cause damage.

Running the Nitro Hammer:

- Before running your Nitro Hammer, it is a good idea to check the water-cooling system to make sure all tubes are properly connected.
- Check over all screws to make sure they are securely fastened.
- Place the boat in water that is at least 8" deep and free of obstacles (weeds, sticks, ducks, muskrats, etc.).
- Periodically remove the drive shaft and relube with a thin coat of petroleum jelly or light grease.
- **CAUTION:** It is common practice to slow down a little for sharp turns. If you don't, there will be an increased chance of flipping over.
- Slowly advance the throttle to full speed and note if the boat has a tendency to turn right or left. Adjust the steering trim knob on your transmitter until the boat runs in a straight line when the steering wheel is at neutral.
- **CAUTION:** Windy conditions cause rough water that will affect the performance of your Nitro Hammer and increase the chances of capsizing.
- Total run time of the Nitro Hammer is approximately 6 minutes (assuming you begin with a full tank of fuel). When you notice an increase in power, it means the fuel tank is nearly empty and it's time to head for shore. As soon as the boat reaches shore, **stop the engine** by pushing forward on the throttle trigger; turn off the receiver and finally the transmitter (in that order).
- **CAUTION:** The engine will be hot! Allow it to cool for a few minutes before restarting.
- Your Nitro Hammer will often take on small amounts of water, especially when running in rough water and when making tight turns. Keep a roll of paper towels handy and dry out the hull interior after every run. If you notice excessive amounts of water in the hull, check for leaks, especially around the hull/deck joint. You may reseal the joint using medium cyanoacrylate (CA) glue.
- Always store your Nitro Hammer with the canopy/hatch cover removed to allow the interior to dry out completely. If you neglect to do this, it may result in corrosion of the electronic components.
- **IMPORTANT:** If, for whatever reason, your boat takes on a large amount of water, swamps or sinks, causing the radio

equipment to get wet, you must do the following immediately: Remove the battery pack and radio equipment from the boat. Allow the components to air dry completely before reassembling. Reinstall the components and check for proper operation before running the boat in water.

PERFORMANCE TRICKS AND TWEAKS

If you are thinking about modifying your Nitro Hammer, keep this in mind: A tremendous amount of research and development has gone into the Nitro Hammer with speed, stability, maneuverability and run time as our primary considerations. Therefore, many of the modifications that you may try in order to increase speed will probably result in decreased performance in other areas. We think our combination of engine and propeller is close to optimum for a boat of this type, so we suggest that you accept those items without change.

Listed below are some ideas to help you “trim out” your boat to get the best performance:

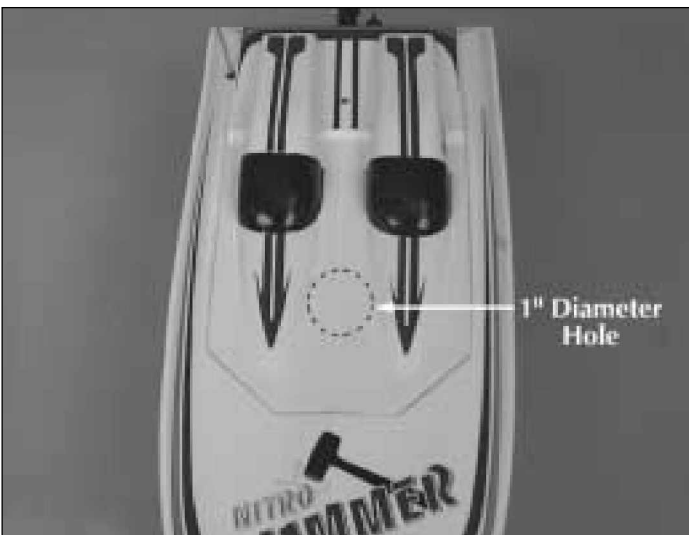

- Cut a 1" diameter hole above the carburetor. This will improve airflow to the carb and increase top end speed.

- Wax the hull with a good quality, non-abrasive automotive wax, such as “carnauba wax”. This will reduce the surface tension (resistance) between the hull and the water, allowing the boat to move faster.

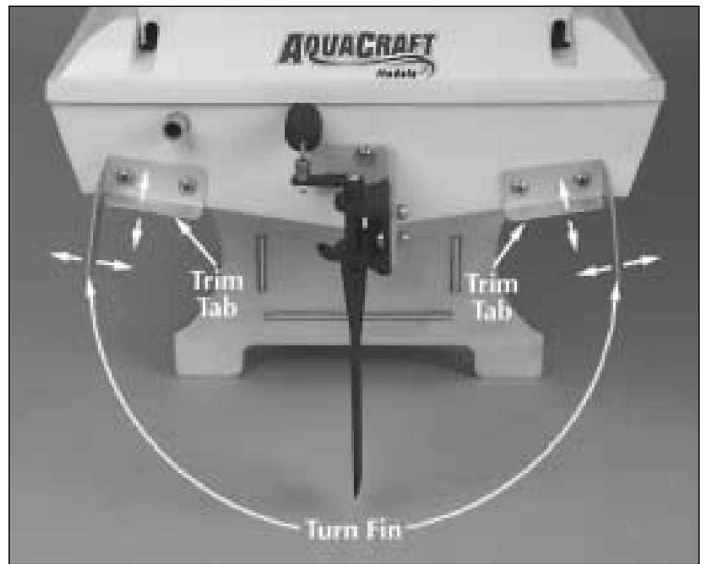

- Adjust the trim plates up or down to maximize speed. There is a fine line between fast speeds and optimum handling. If the boat tends to “porpoise” (meaning that the nose of the boat bobs up and down on straights), bend the trim plates down slightly. Repeat this process until it stops.
- Sharpen the leading edge of the rudder. This will reduce resistance.

RACING

Although it is very enjoyable to go out and run the Nitro Hammer by yourself, we think the real fun and excitement is experienced when you get involved in *RACING!*

Racing does not have to be an organized and sanctioned competition to be fun. In fact, small informal races can be very exciting without the stress that comes with formal events.

Here are some suggestions for setting up a simple racecourse for boats:

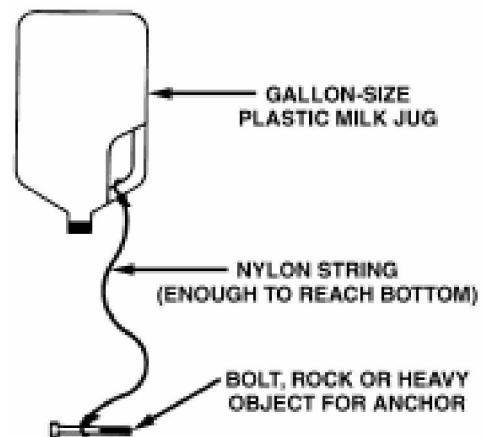

- Make 2 to 4 simple and inexpensive “marker buoys” with empty milk jugs, string and heavy objects for anchors, similar to the above sketch.

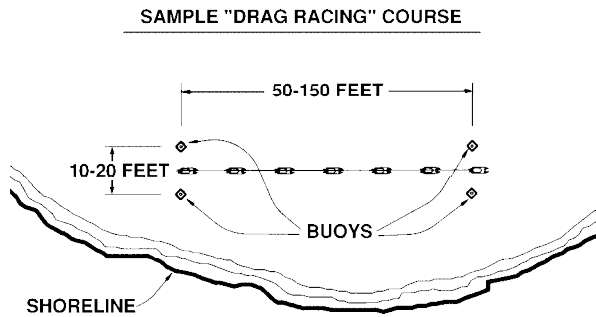

• For "drag racing" place the buoys similar to the above sketch.

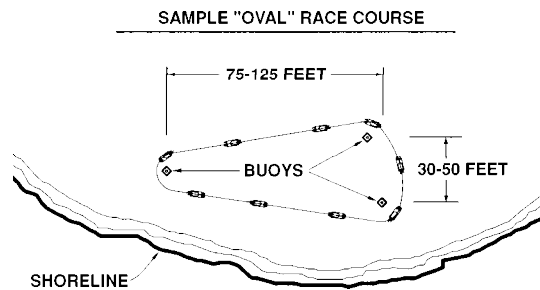

•For "oval racing" place the buoys similar to the above sketch. **NOTE:** The above patterns are not based on any sort of official standards; therefore, you may set up racecourses any way you desire, using your imagination to make the races more interesting. Usually the smaller courses will provide more action and excitement.

The length of the races can be determined by a set number of **laps** around the buoys (for example, the first boat to complete 5 laps is the winner); or by **time** (for example, whoever is leading at the end of two minutes is the winner).

The Waiting Game

If your Nitro Hammer should happen to stall or capsize, water currents will *slowly* carry it to shore. The bad news is that the boat could be carried to the opposite shore. When surveying areas to run your Nitro Hammer, keep in mind things like wind direction, size of the lake, strength of river currents, etc. **HELPFUL TIP:** Use a fishing rod with at least 12lb. line and a tennis ball tied to the end to retrieve a stalled or capsized model boat.

GOOD LUCK AND GREAT BOATING!

ORDERING REPLACEMENT PARTS

To order replacement parts for the AquaCraft Nitro Hammer, use the order numbers in the **Replacement Parts List** that follows. Replacement parts are available only as listed and can be purchased from hobby shops or mail order/ Internet order firms. Hardware items (screws, nuts, bolts) are also available from these outlets. If you need assistance locating a dealer to purchase parts, visit www.hobbico.com and click on "Where to buy". If this kit is missing parts, contact **Hobbico Product Support**.

<u>Order #</u>	<u>Item</u>
HCAB8701.....	Rudder Assembly
HCAB8600.....	Radio Box
HCAB6901	Fuel Tank
HCAB9040	Trim Tabs
HCAB7850	Shaft Set
HCAB7000	Hatch (White)
HCAB6501	Engine Mounting Plates
HCAB6301.....	Decal Sheets
HCAB7800	Pushrod / Linkage Set
HCAB7750.....	Propeller (2)

ENGINE TROUBLESHOOTING

