



HAMMER™



AQUACRAFT™
Models by **HOBBICO®**

Warranty

- AquaCraft™ will warrant this kit for 90 days after the purchase from defects in materials or workmanship. AquaCraft will either repair or replace, at no charge, the incorrectly made part.
- Make sure you save the receipt or invoice you were given when you bought your model! It is your proof of purchase and we must see it before we can honor the warranty.
- To return your Hammer™ for repairs covered under warranty, you should send your boat to:

Hobby Services
3002 N. Apollo Drive, Suite 1
Champaign, Illinois 61822
Attn: Service Department
Phone: (217) 398-0007 9:00 am - 5:00 pm Central Time M-F
E-mail: hobbyservices@hobbico.com

Before Building:

Thank you for purchasing the Hammer! We at AquaCraft know how exciting a new R/C boat purchase can be and we know you're anxious to get started, but please take time to read these instructions carefully and completely before attempting to operate your model. This manual contains the instructions you need to *safely* operate and maintain your boat. As with any hobby, there is the possibility of injury. Arming yourself with knowledge is the best way to avoid injury. If for any reason you think that this model is not for you, return it to your local dealer immediately. **PLEASE NOTE: Your hobby dealer cannot accept a return on any model after the final assembly sequence has begun.**

TABLE OF CONTENTS

INTRODUCTION	2
SAFETY PRECAUTIONS.....	2
REPAIR SERVICE	2
SPECIFICATION & DESCRIPTION CHANGES	2
ITEMS REQUIRED FOR COMPLETION.....	2
USEFUL TOOLBOX ITEMS	2
BOAT TERMINOLOGY	3
FINAL ASSEMBLY	3
Transmitter Assembly	3
Battery Pack Installation	3
Check the Radio System	4
RUNNING THE HAMMER	5
RACING	6
ORDERING REPLACEMENT PARTS.....	6

SAFETY PRECAUTIONS

- Do not attempt to charge battery packs in the immediate vicinity of swimming pools, lakes, rivers, oceans, inland seas, etc. Above all, **NEVER ATTEMPT TO OPERATE A CHARGER IF YOU, THE CHARGER, OR THE BATTERY PACK ARE WET.**
- Always remove the battery pack from the boat before recharging.
- This boat is controlled by radio signals, which are susceptible to possible interference from other R/C transmitters, paging systems, or other electrical noise. **Before turning your radio transmitter and receiver on,** make sure no one else in the area is operating a radio on the same frequency (channel).
- Do not touch the propeller anytime the electronics are turned "ON". **Pay close attention** to items such as loose clothing, shirtsleeves, ties, scarves, long hair or any loose objects that may come in contact with the spinning propeller. If your fingers, hands, etc. come in contact with the spinning propeller, you may be severely injured.
- The speed and mass of this boat can inflict property damage and severe personal injury if a collision occurs. **Never run this boat in the presence of swimmers** or where the possibility of collision with people or property exists.
- Electric motors can generate considerable heat. **Do not touch any part of your motor** until it has cooled. Touching the motor immediately after running the Hammer may possibly result in a serious burn.

If the buyer is not prepared to accept the liability associated with the use of this product, the buyer is advised to return this kit immediately in new and unused condition to the place of purchase.

REPAIR SERVICE

Repair service is available anytime.

After the 90-day warranty, you can still have your Hammer repaired for a small charge by the experts at AquaCraft's authorized repair facility, **Hobby Services**, at the address listed on the front page of this manual.

To speed up the repair process, please follow these instructions:

1. Under all circumstances, return the **ENTIRE** system (boat and radio).
2. Make sure the electronics are turned off and all batteries are removed.
3. Send written instructions which include a list of all items returned, a **THOROUGH** explanation of the problem, the service needed and your phone number during the day. If you expect the repair to be covered under warranty, be sure to include a proof-of-purchase date (your store receipt or purchase invoice).
4. Also be sure to send your full return address.

SPECIFICATION & DESCRIPTION CHANGES

All pictures, descriptions and specifications found in this instruction manual are subject to change without notice. AquaCraft maintains no responsibility for inadvertent errors in this manual.

ITEMS REQUIRED FOR COMPLETION

- DuraTrax® 7.2 volt 1500mAh NiCd battery pack (DTXC2100), one required.
- AC/DC Piranha™ Peak Power charger (DTXP4000).
- "AA" batteries, eight (8) batteries are required for the transmitter.

USEFUL TOOLBOX ITEMS

As with any hobby, it is a good idea to assemble a useful collection of tools to bring along anytime you head out to the pond. Here are some items you may wish to keep handy.

- #1 Phillips screwdriver (HCAR1022)
- 1.5mm Hex Driver (HCAR1150)
- 4mm socket or wrench
- Paper towels

BOAT TERMINOLOGY

BOW: The front of the boat

STERN: The back of the boat

PORT: This is the left side of the boat when aboard and facing the front (bow). An easy way to remember this is that port and left both contain four letters

STARBOARD: This is the right side of the boat when aboard and facing the front (bow)

HULL: The body of the boat

DECK: The top of the boat

RUDDER: The hinged vertical plate mounted at the stern that controls steering

FINAL ASSEMBLY

Decals have been provided for your Hammer. Simply peel and stick! See the photos on the box for decal placement.

TRANSMITTER ASSEMBLY

Important Note: The transmitter is not water resistant and should never come in contact with water.

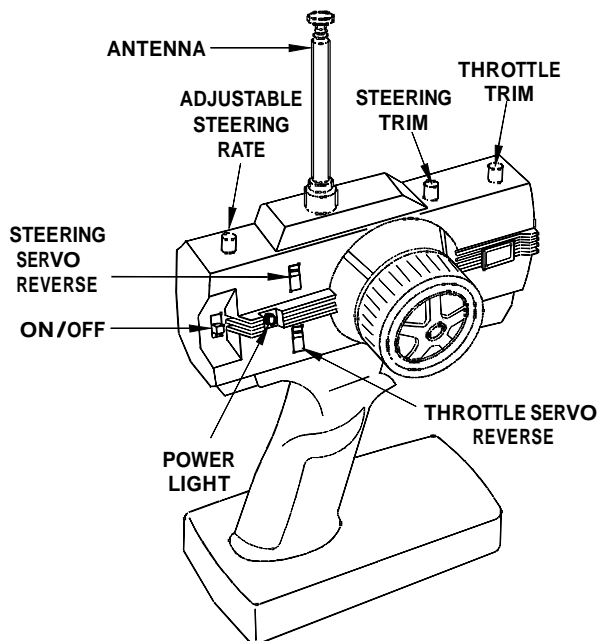

○ 1. Remove the transmitter antenna from the parts bag and screw it into the top of the transmitter. To ensure that the antenna is attached, lightly pull on the base of the antenna. If it slides out, it is not installed properly.

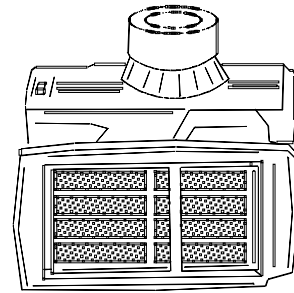

Install (8) new "AA" batteries

○ 2. Slide off the battery door on the bottom of the transmitter. Install 8 fresh "AA" batteries into the bottom of the transmitter in the configuration molded into the battery holder. Re-install the battery door onto the bottom of the transmitter.

○ 3. Turn the transmitter "ON" using the switch on the front. The red LED light next to the on/off switch should light up. If the LED does not light up, turn the transmitter off and check to make sure that the batteries are installed properly. **If you see a flashing LED, the batteries are low and need to be**

BATTERY PACK INSTALLATION

IMPORTANT! Never leave a charger and battery pack unattended while charging. Use only the recommended battery pack and an appropriate charger. Do not attempt to charge the battery while it is installed in the Hammer.

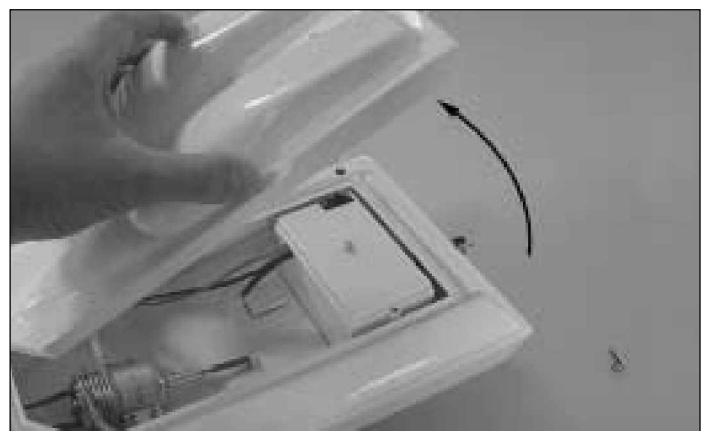
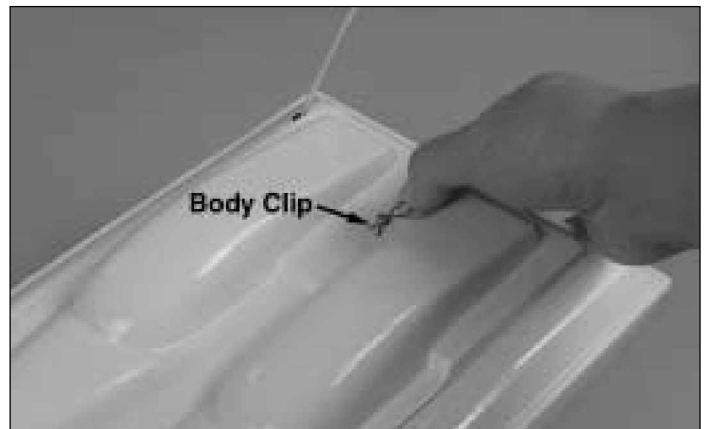

○ 4. Remove the body clip at the rear of the top deck and carefully remove the hatch.

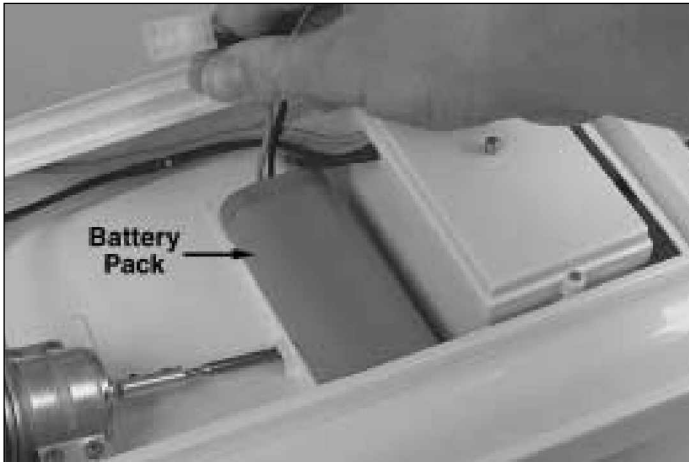
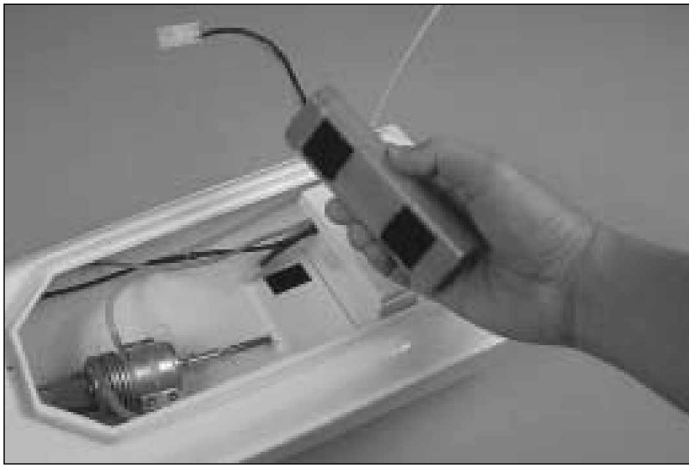

○ 5. Peel the backing off of the supplied hook & loop material and apply the “loop” side to your 6-cell battery pack. Place a fully charged battery pack onto the battery tray as

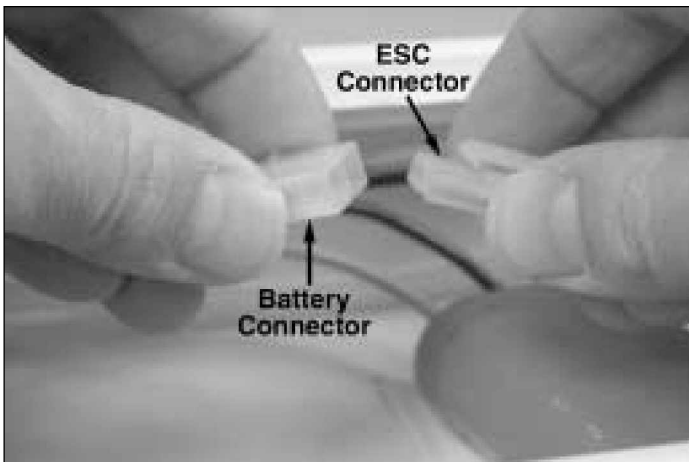

○ 6. Plug the battery pack into the boat's ESC (Electronic Speed Control) battery connector. Do not force them together; they are designed to fit together only one way.

CHECK THE RADIO SYSTEM:

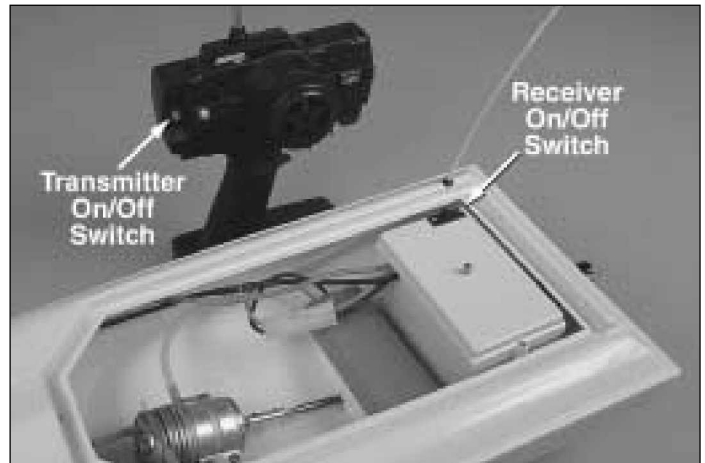

○ 7. Turn the power “ON” to the transmitter and receiver (in that order).

○ 8. If the boat's propeller begins to spin once power is turned “ON”, make sure your transmitter is “ON” and simply rotate the throttle trim knob located atop the transmitter until

○ 9. Standing behind the boat with the radio system turned “ON”, rotate the steering wheel of your transmitter to the left. The back of the rudder should move towards the left. Rotate the steering wheel of your transmitter to the right. The back of the rudder should move towards the right. If this is not the case, simply move the transmitter's steering servo reverse

○ 10. Squeeze the trigger on the transmitter; this should activate the propeller in a counter-clockwise motion. If this is not the case, try moving the throttle servo reversing switch to the other position. Pushing the trigger forward will activate the propeller in a clockwise rotation; this is the “REVERSE” feature and it can be used to either back out of precarious water or slow the boat down quickly.

○ 11. The D/R knob located atop the transmitter is the steering rate adjustment. Turning the knob to the right increases the total movement of the rudder while turning it to the left decreases the rudder movement.

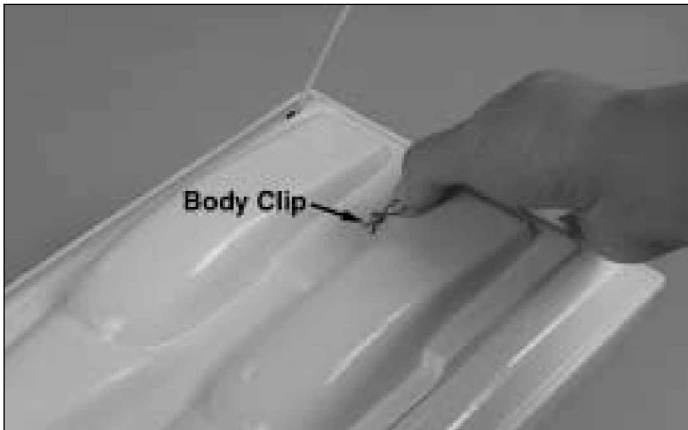
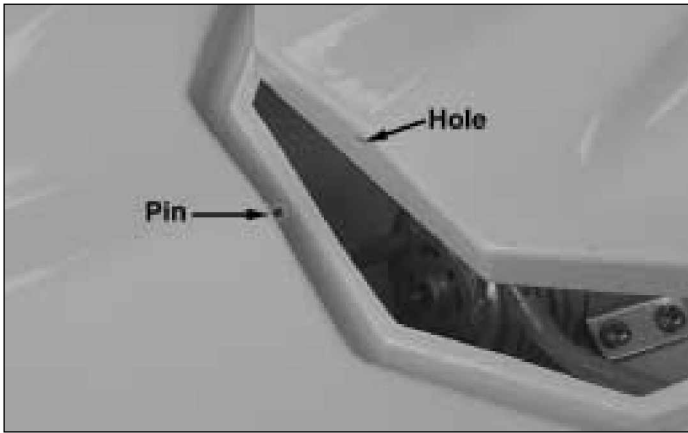

○ 12. Replace the hatch as shown, by first placing the hole at the front of the hatch cover over the pin at the front of the hatch opening. Replace the body clip. The boat is powered "UP" and ready to go!

○ 13. After running, turn the power "OFF" to your boat's receiver and then transmitter (always, in that order).

RUNNING THE HAMMER

PLEASE READ BEFORE Running the Hammer:

- **NEVER** attempt to swim after a stalled or capsized boat! Wait patiently for the wind currents to return the boat to shore or use a tennis ball attached to the end of a fishing rod to retrieve a stalled or capsized boat.
- It is dangerous to operate any R/C vehicle at any time that there is not sufficient light.
- R/C models produce vibrations which will cause screws, nuts, bolts, etc, on your model to become loose over time. **It is important to make sure that all hardware is secure** before operating your model.
- **The edges of the propeller are very sharp and can cut your fingers** if you are not careful. At no time should you ever attempt to stop the prop with your hand. In the event that weeds become entangled in the propeller, turn the

- **CAUTION:** Your Hammer may take on small amounts of water, especially when running in rough water due to high winds or when making tight turns. Keep a roll of paper towels handy and dry out the hull interior after every run.
- Total run time of the Hammer is approximately 6-10 minutes (assuming you begin with a fully charged battery pack). When you notice a decrease in power or sluggish steering response, it means the battery pack is nearly drained and it's time to head for shore. As soon as the boat reaches shore, turn off the power to the boat's receiver and transmitter (in that order).
- **CAUTION: The motor may be hot!** Allow it to cool for a few minutes before attempting to remove the battery pack.
- After running, store your Hammer with the hatches opened to allow the interior to dry out completely. If you fail to do this, it may result in corrosion of the electronic components.
- **IMPORTANT:** If, for whatever reason your boat takes on a large amount of water causing the radio equipment to get wet, you must do the following immediately: Remove the battery pack and radio equipment from the boat. Allow the components to air dry completely before reassembling. Reinstall the components and check for proper operation before running the boat in water.

Launch Procedure:

1. Turn the power "ON" to the transmitter and receiver (in that order).
2. Gently place the boat in water that is at least 8" deep and free of obstacles (weeds, rocks, sticks, ducks, muskrats, etc.).
3. Slowly advance the throttle to full speed and note if the boat has a tendency to turn right or left. Adjust the steering trim knob on your transmitter until the boat runs in a straight line when the steering wheel is at neutral.
4. When finished running, be sure to turn the power "OFF" to your boat and transmitter (in that order).

The Waiting Game

If your Hammer should happen to stall, wind and/or water currents will slowly carry it to shore. The bad news is that the boat could be carried to the opposite shore. When surveying areas to run your boat, keep variables in mind such as wind direction, size of the lake, strength of river currents, etc. **Above all, NEVER attempt to swim after a stalled boat.**

HELPFUL TIP:

Use a fishing rod with at least 12lb. line and a tennis ball tied to the end to retrieve a stalled boat.

GOOD LUCK AND GREAT BOATING!

RACING

Although it is very enjoyable to go out and run the Hammer by yourself, we think the real fun and excitement is experienced when you get involved in *RACING!*

Racing does not have to be an organized and sanctioned competition to be fun. In fact, small, informal races can be very exciting without the stress that comes with formal events.

Here are some suggestions for setting up a simple race course for boats:

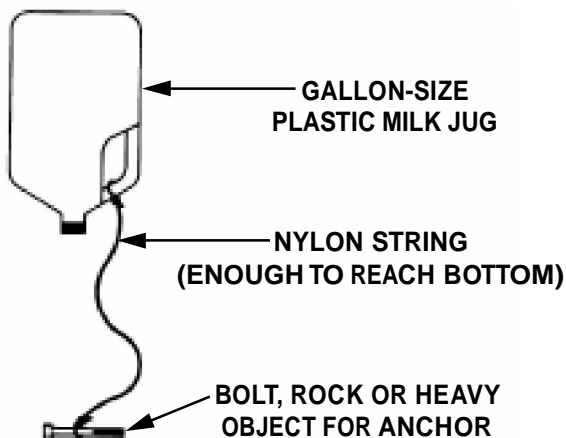

- Make 2 to 4 simple and inexpensive “marker buoys” with empty milk jugs, string and heavy objects for anchors, similar to the above sketch.

SAMPLE “DRAG RACING” COURSE

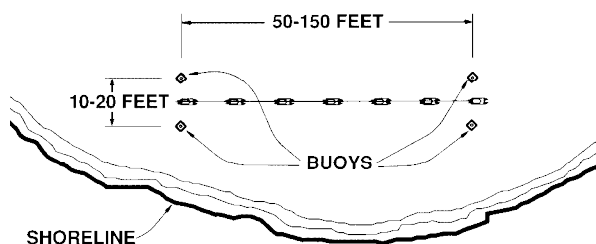

- For “drag racing” place the buoys similar to the above sketch.

SAMPLE “OVAL” RACE COURSE

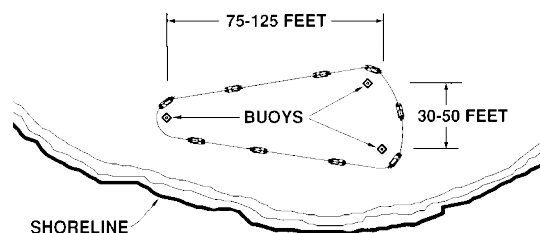

- For “oval racing” place the buoys similar to the above sketch. **NOTE:** The above patterns are not based on any sort

of official standards; therefore, you may set up race courses any way you desire, using your imagination to make the races more interesting. Usually the smaller courses will provide more action and excitement.

The length of the races can be determined by a set number of **laps** around the buoys (for example, the first boat to complete 5 laps is the winner); or by **time** (for example, whoever is leading at the end of two minutes is the winner).

ORDERING REPLACEMENT PARTS

To order replacement parts for the AquaCraft Hammer, use the order numbers in the **Replacement Parts List** that follows. Replacement parts are available only as listed and can be purchased from hobby shops or mail order/ Internet order firms. Hardware items (screws, nuts, bolts) are also available from these outlets. If you need assistance locating a dealer to purchase parts, visit www.hobbico.com and click on “Where to buy”. If this kit is missing parts, contact **Hobbico Product Support**.

REPLACEMENT PARTS LIST

Order #	Item
HCAB6309	DECAL SHEETS
HCAB6505	MOTOR BRACKETS
HCAB6700	WATERPROOF SWITCH BOOT
HCAB7003	HATCH (WHITE)
HCAB7765	PROP SET (2)
HCAB7851	DRIVE SHAFT WITH COUPLER
HCAB7852	DRIVE DOG WITH PROP NUT
HCAB8601	RADIO BOX
HCAB8705	RUDDER SET WITH CONTROL ARM
HCAB9041	TRIM TABS WITH SCREWS
HCAM7037	SPEED CONTROL

CHECK OUT THESE OTHER SENSATIONAL AQUACRAFT BOATS!

PARADISETM

HCAB01** Paradise Sailboat



BRISTOL BAY
ELECTRIC R/C READY-TO-RUN FISHING BOAT



HCAB60** Bristol Bay Fishing Boat

CHECK OUT THESE OTHER SENSATIONAL AQUACRAFT BOATS!

AIR FORCE™



HCAB27** Air force RTR
HCAB5027 Air Force ARR

REEFRACER™



HCAB12** Reef Racer

**NITRO
HAMMER**™



HCAB26** Nitro Hammer RTR